



STEP 1 – PRIOR TO INSTALLATION

- A) Bushwacker only** approves installing the flares according to these written instructions with the hardware provided. **WARNING:** Failure to install according to these instructions will invalidate the warranty. This includes, but is not limited to using alternative installation methods, hardware, or materials. **DO NOT USE:** Loctite, SuperGlue, or similar products on the hardware or the flares.
- B) Fit:** Verify the fit of the flares to vehicle. (Some filing, sanding, or cutting may be necessary to ensure proper fit).
- C) Painting:** (Optional) if paint is desired it must be done prior to installing flares on vehicle. Clean outer surface with a good grade degreaser. **DO NOT USE LACQUER THINNER OR ENAMEL REDUCER AS A DEGREASER.** Wipe outer surface thoroughly with a tack rag prior to paint. Application of plastic adhesion promoter for ABS plastic as per your paint system manufacturer's recommendations is required. Paint flares using a high quality enamel, or polyurethane automotive paint. If painting edge trim (not recommended), use a flex additive.
- D) Performance:** Using larger Tires may increase the area required to turn the vehicle. Some Tire/Rim combinations may require lowering bump stops and or installing steering stops to prevent tire from contacting flare.
- E) Exhaust System:** Modifications may be necessary to maintain a minimum 4" clearance between flares and exhaust pipes. (Exhaust gases should not vent directly onto flares)
- F) Metal Protection:** All exposed fasteners and bare metal should be treated with rust resistant paint **BEFORE** installing flares. Spray inner fender wells with undercoating **AFTER** flare attachments have been completed.
- G) Decals:** Flares may interfere with existing decals on vehicle. If you wish, remove decals prior to installation of flares.
- H) Care & Cleaning:** Bushwacker fender flares are built to last; any detergent you use to wash your vehicle is sufficient to clean the flare. Do not use any harsh abrasive detergents.

GMC Cut-Out™ Fender Flares Set of 4

Set Part #40947-02

Rev-10 03/14/2016

For complete fitment info visit : www.bushwacker.com

TOOLS FOR EASY INSTALLATION:













- 1/2" Wrench
- 7mm Socket
- 3/8" Ratchet
- Electric Drill
- Unibit or 5/16" Drill Bit
- 3/32" Drill Bit
- #2 Phillips Driver
- Grease Pencil
- Awl (optional)
- Body Filler Spreader or Plastic Spacer
- Sledge Hammer
- Pry Tool
- 1/4" Masking Tape
- Tape Measure
- String or Twine
- Reciprocating Saw
- Sawsall
- Cut Off Tool

PLEASE READ: Dirt and debris can become lodged between the fender flares and the vehicle's fenders, causing scratching and paint wear from vibration. Lund International is not responsible for any damage, and the installation of our fender flares is done with the buyer's understanding that this scratching and paint wear may occur.

LIMITED LIFETIME WARRANTY AGAINST ANY MANUFACTURING DEFECTS

- To claim a warranty, you must provide Proof of Purchase.

Included in Hardware Kit:

- | | | | | | | |
|---|--|--|--|---|---|---|
| 1. 
SW1-0067,
5/16 x 18 x 3/8"
SS Torx Screw,
36 pcs | 2. 
WA1-0012,
.320 x .700 x .03
SS Washer,
36 pcs | 3. 
NU1-0019,
5/16-18 Jam Fin.
Nylock Nut,
36 pcs | 4. 
MT1-0002,
1" x 1" x .017"
Black Tab,
12 pcs | 5. 
CL1-0005,
Dacromet "S"
Spring Clip,
12 pcs | 6. 
SW1-0050,
10 x 5/16 Phillips
Truss Screw,
12 pcs | 7. 
SW1-0056,
#8 x 3/4"
PH Screw,
22 pcs |
| 8. 
WA1-0017,
1/4 x 1-1/4" Black
Fender Washer
4 pcs | 9. 
NU1-0007,
#12 "U" Spring
Nut,
4 pcs | 10. 
SW1-0057,
#14 x 3/4" Phillips
Truss Tap Screw,
4 pcs | 11. 
SW1-0052,
T-45 Torx Bit,
1 pc | 12. 
GP1-0008,
Duro (NC02/S 70)
Edge Trim,
358 inches | | |

STEP 2 - EDGE TRIM INSTALLATION

- A)** Peel two to three inches of red vinyl backing away from Edge Trim (GP1-0008) tape. Applying the adhesive side of the edge trim to the inner side of the flare, affix the edge trim to the top edge of the flare (the portion that comes in contact with the vehicle).
- B)** Press edge trim into place along the top edge of the flare in one-foot increments, pulling red vinyl backing free as you continue to work your way around the top edge of the flare.

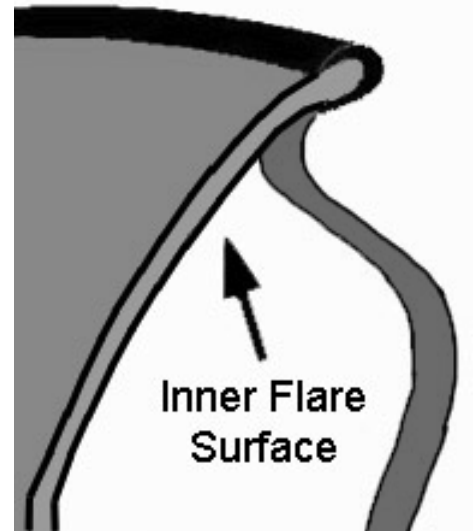

Pocket Hardware Installation Procedures:

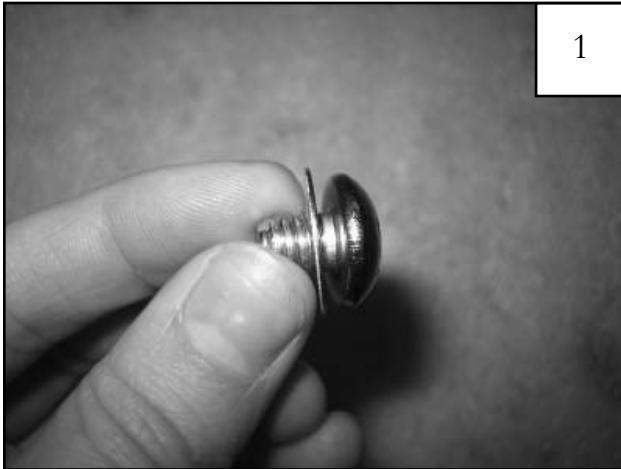

Put a Washer (WA1-0012) on each Bolt (SW1-0067).



Put each Bolt through a pocket hole in the flare, bolt head on the outside.



Place a Nut (NU1-0019) over the end of each Bolt and tighten, using a 1/2" wrench for the Nut and the supplied Torx Bit (SW1-0052) for the Bolt. Repeat for remaining pockets.

Front Flare Installation Procedures (Driver's Side):

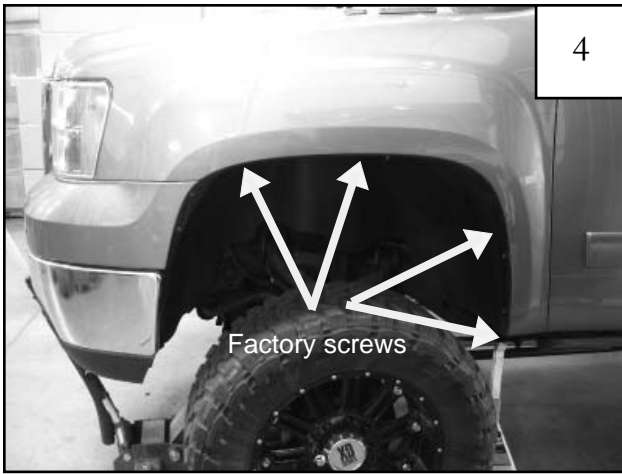

Using a 7mm socket, remove four factory screws from wheel well and save for reinstallation.



Support vehicle and remove tire.



Using a pry tool, remove plastic factory fastener from wheel well liner.



Pull back plastic shield and tie it to the axle with string or twine to keep it out of the way.

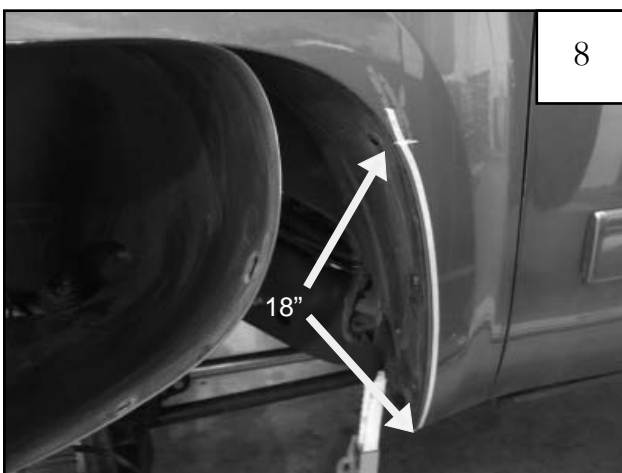

At rearward side of wheel well measure up 18" from the bottom edge of fender and mark vehicle with a grease pencil. Then at 1/16" in from wheel well, apply masking tape up to 18" mark.



Cut along the outside of fender to 18" mark. See picture in step 10.

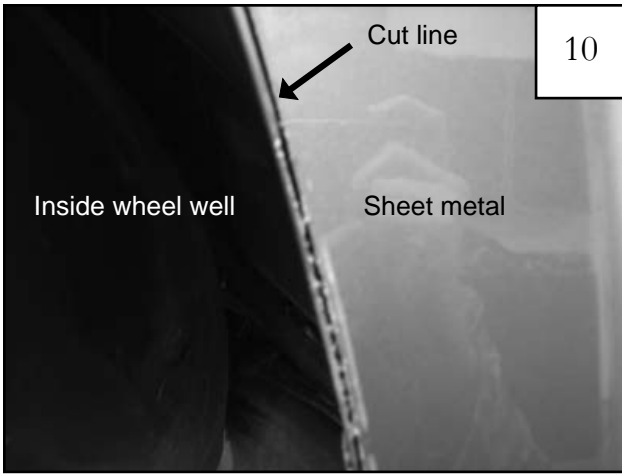

10

1/16" cut line from step 9.

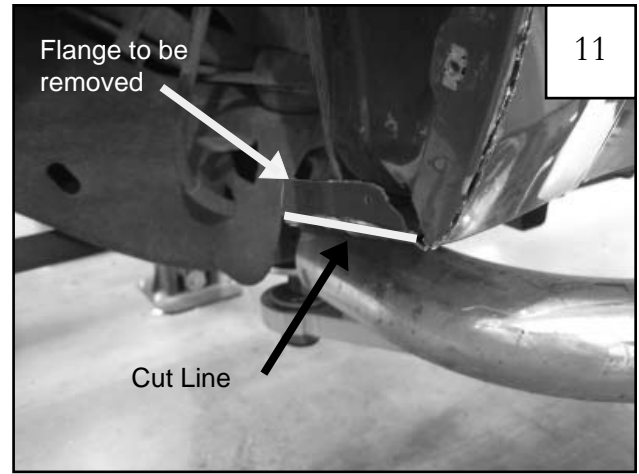

11

Cut flange off of lower rearward edge of inside of wheel well.

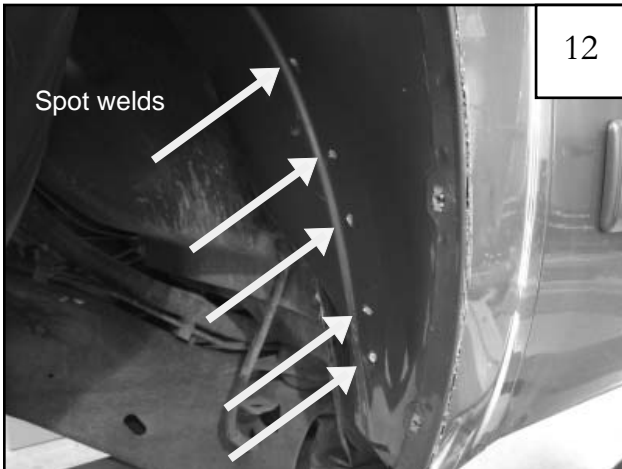

12

Use unibit or 5/16" drill bit to drill through spot weld locations shown here to separate metal inner wheel well from fender.



13

Bend inner fender metal away from fender.

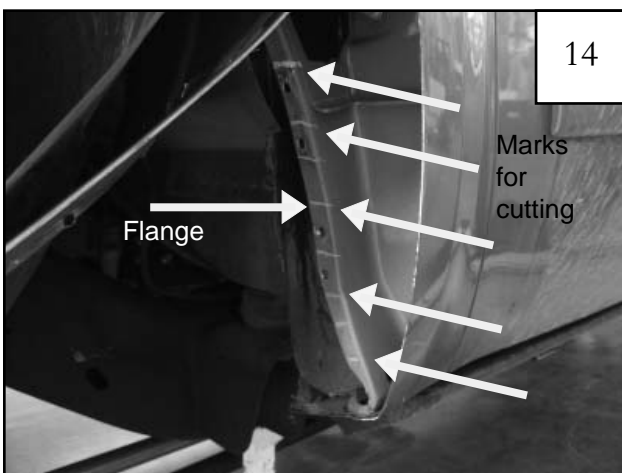

14

Mark the flange on the inner fender support structure approximately every 2". *NOTE: Horizontal marks will be cut to create metal tabs.*



15

Cut the inner structure on marks made in previous step.



Bend lip straight with pliers between cuts made in previous step. *NOTE: In Step 20, existing cuts will be extended after reference lines are marked.*

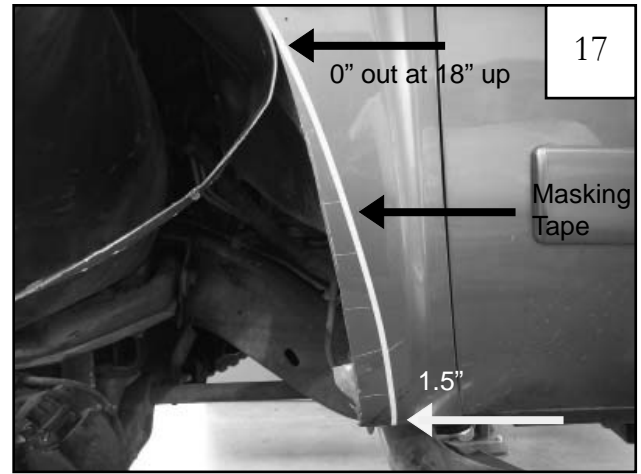

At the bottom of cut fender, measure 1.5" toward door seam and make a mark. Use masking tape to created a reference line from mark at bottom up to the 18" point.



Cut fender approximately every 2" up to edge of masking tape.



Bend all metal tabs outward.

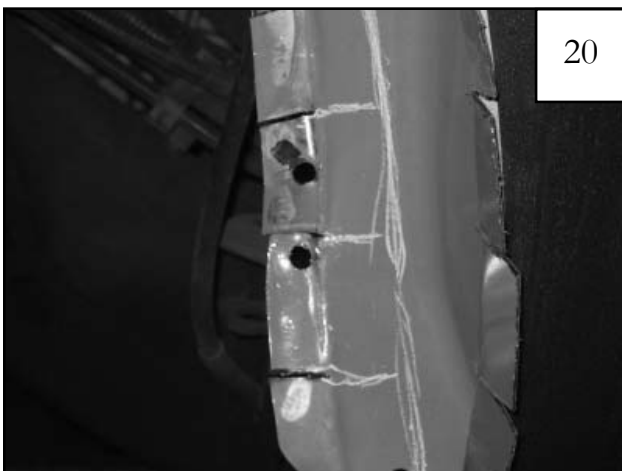

Using outer edge as a guide mark along flange parallel with the inner wall. Mark flange to extend cut lines to line parallel with the inner wall.

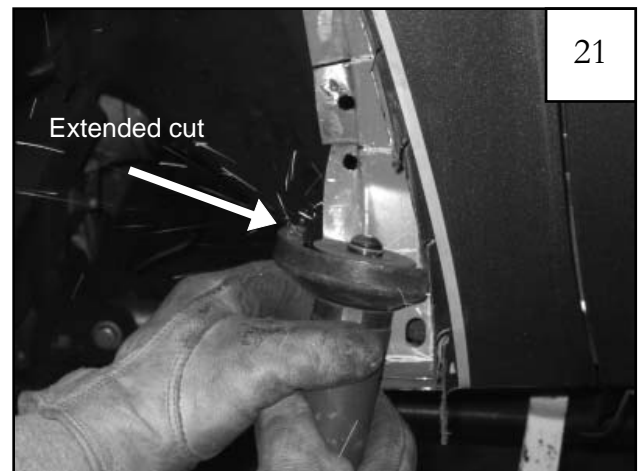

Continue cutting flange at existing cut lines, stopping at the line parallel to the inner wall.

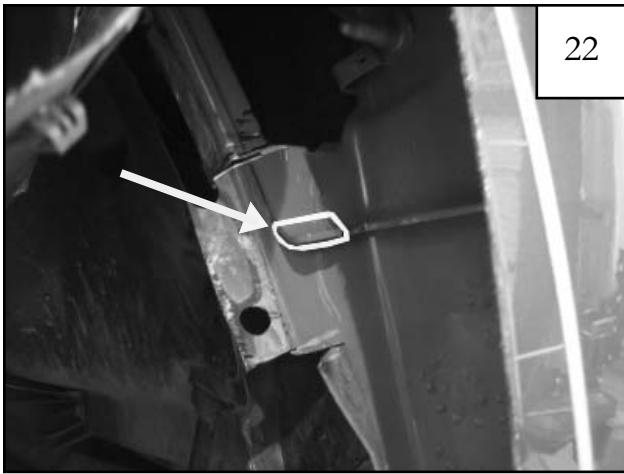

Cut off outlined tab to make bend in the next step easier.

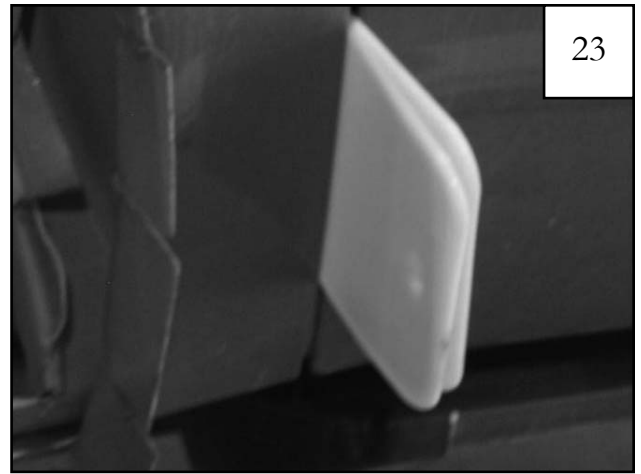

To prevent paint damage, insert body filler spreader or plastic spacer between fender and door. This will keep the fender from hitting the door edge while pounding back sheet metal in the next few steps.

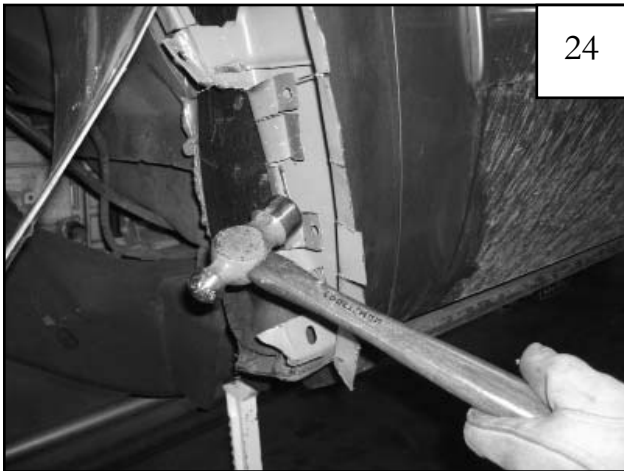

Bend inner support over and use a hammer to flatten against wall inside fender.



Inner flange flush against wheel well wall.

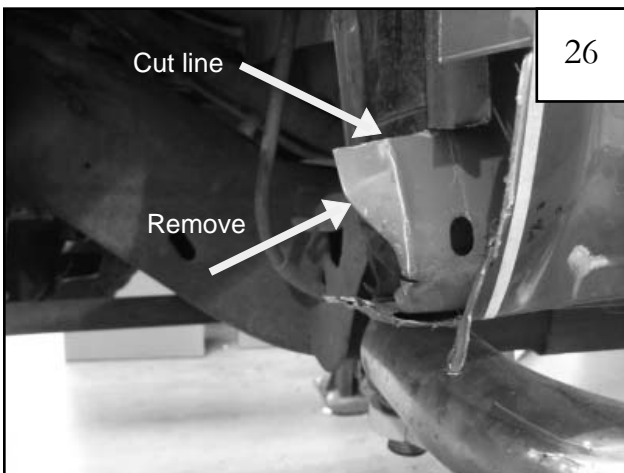

Mark the remaining inner metal at cut line and remove outermost section. *Note: After bending inner piece over, additional trimming may be required.*



Bend remaining metal back even with other tabs. *Note: Remove any additional overlap.*

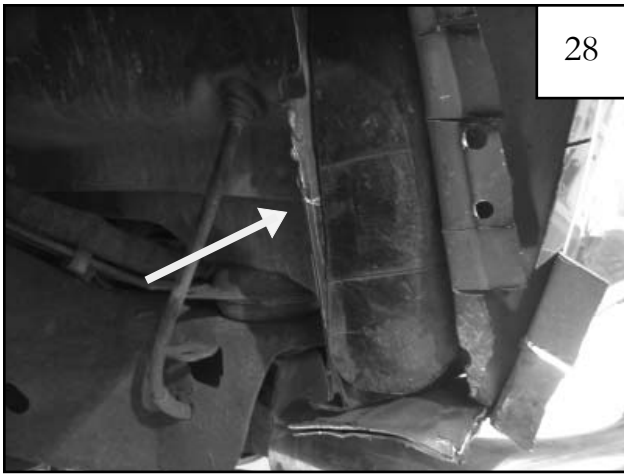

28

Mark inner pinch seam 8.25" from the bottom at location shown.



29

Cut pinch seam at mark made in previous step. Bend flange inward even with firewall.

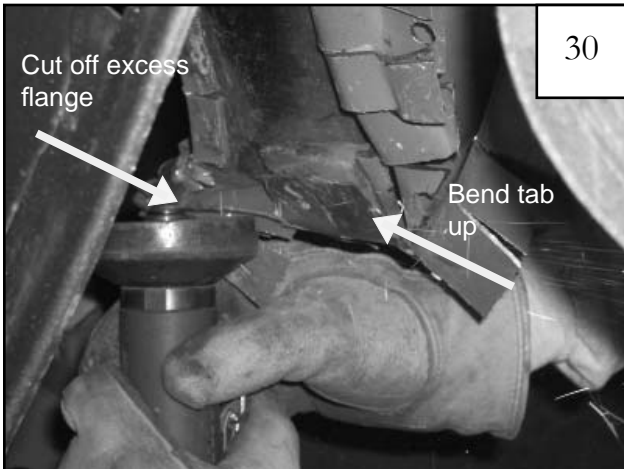

30

Cut off excess flange

Bend tab up

Bend the bottom tab up and cut off excess flange metal.

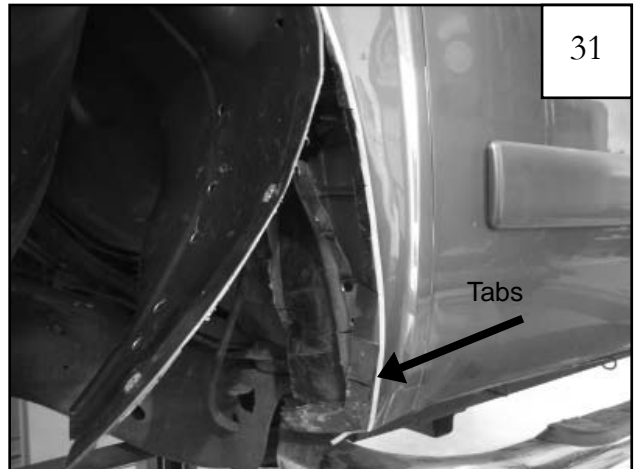

31

Tabs

Pound back metal of firewall below cut made in previous step with a sledge hammer. Tabs bent outward in step 19 should be bent into the wheel well.

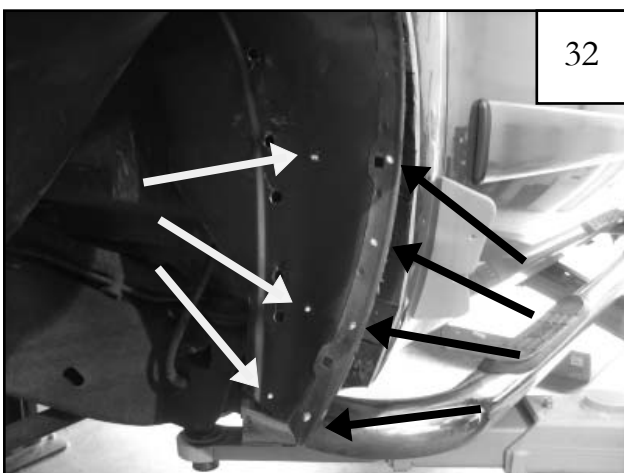

32

Mark seven locations in approximate places shown so metal wheel well liner can be reattached. Hold flare to vehicle to ensure that marks are at least an inch away from holes in the flare.



33

With 3/32" drill bit, drill through mark and the bent tabs of metal behind them for four locations along edge of wheel well.

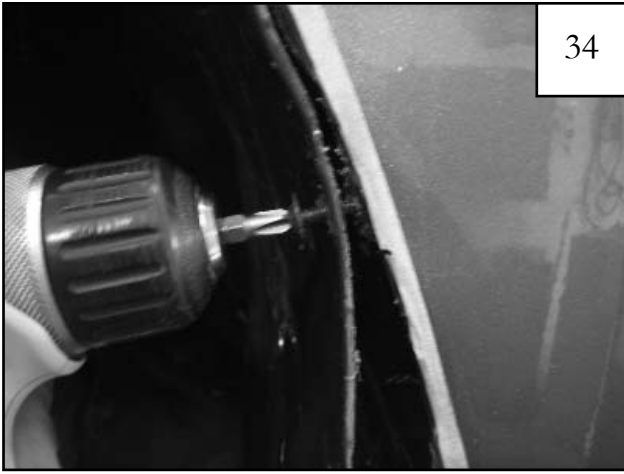

34

Starting with the top location, fasten inner fender metal to bent tabs of outer fender with Screws (SW1-0056) through holes drilled in last step (4 locations).

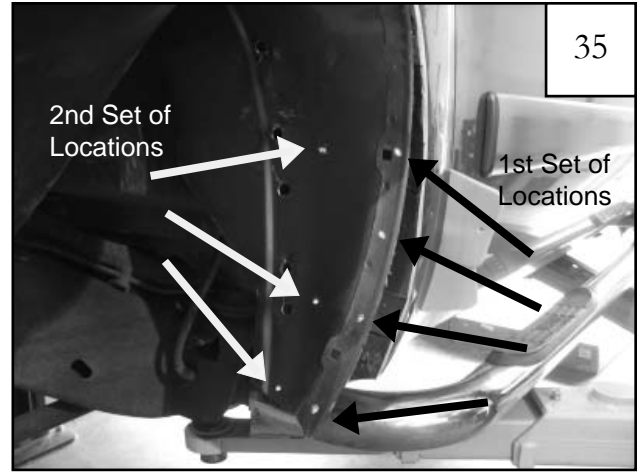

35

Repeat steps 33 & 34 for three locations further inside wheel well.

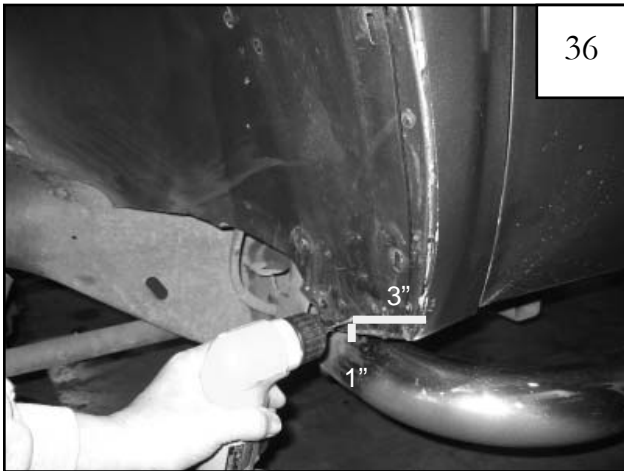

36

Put splash shield back in place. With a 3/32" bit, drill a hole 3" in from corner of fender and 1" up from bottom edge.

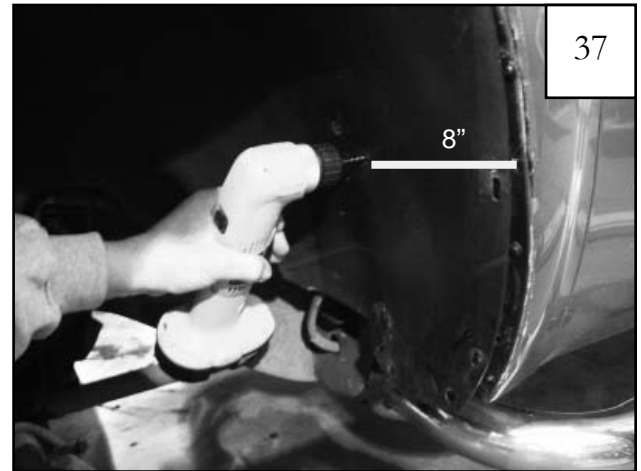

37

Using a 3/32" bit, drill a hole 8" in from hole in wheel well liner.

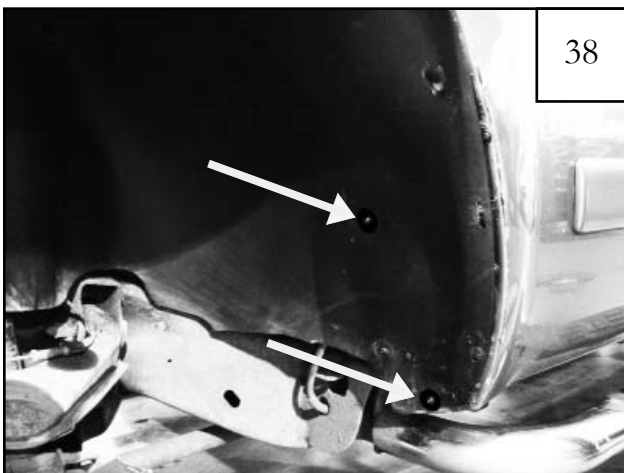

38

Fasten wheel well liner to body with Screws (SW1-0056) and Washer (WA1-0017) through the holes drilled in the previous two steps.



39

Using a 7mm socket reinstall two factory screws through flare, holes in splash shield, and into factory screw clips at top two locations.



At two locations in the rearward side of the flare, drill through hole in flare and into sheet metal of vehicle.



Install Screws (SW1-0056) through flare and into hole in sheet metal in both locations.



Reinstall wheel. Completed front flare installation.

Rear Flare Installation Procedures (Driver's Side):



For 2011-UP ONLY: Using a pry tool remove factory installed tufflocs .



Tufloc locations
NOTE: If fender liner is installed. Remove factory tufflocs.



Holding flare in position on fender, use a grease pencil to mark eight hole locations.

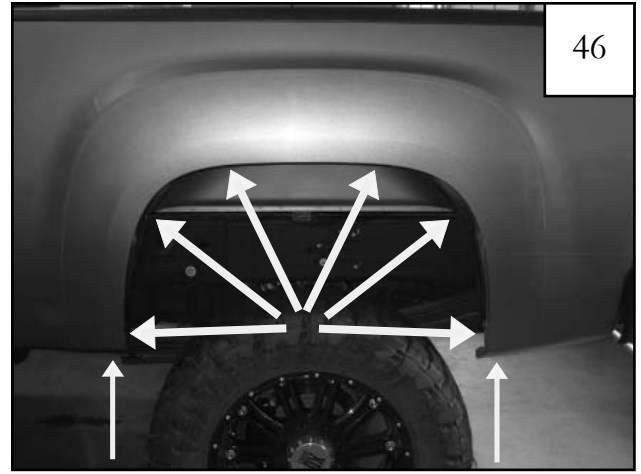

Eight hole locations.



Center a supplied Clip (NU1-0007) over the marks made in Step 45. Clips may need to be adjusted to align with holes in flare. *Note: The raised collar on the clip should face upward into the interior of the fender.*



Clip (NU1-0007) locations.

Note: if fender liner installed remove factory tuff locks.

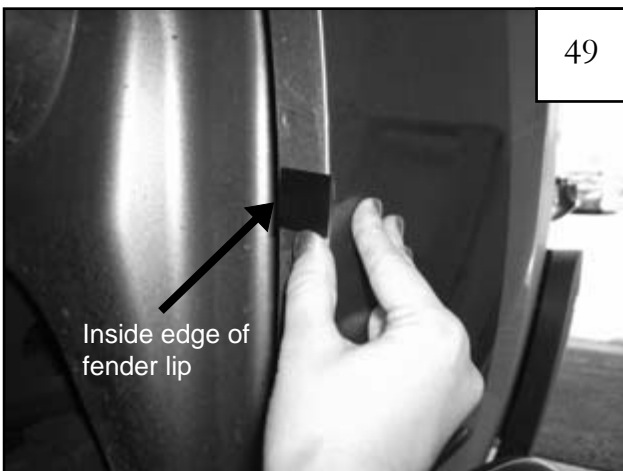

Center a supplied Tab (MT1-0002) over the six remaining marks made in Step 46, aligning edge of tab with inside edge of fender lip (tab may extend over outside of fender).

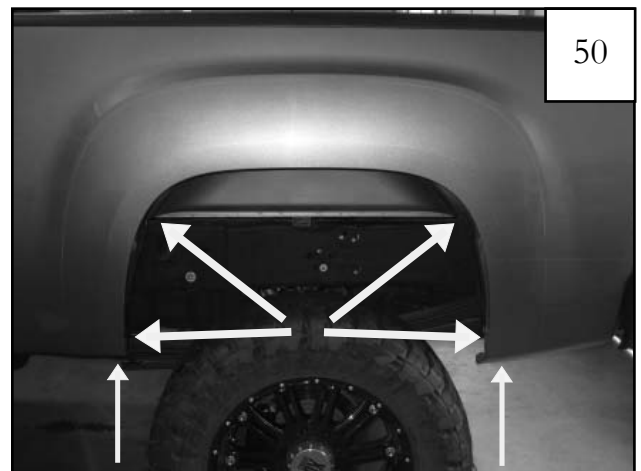

Tab locations.

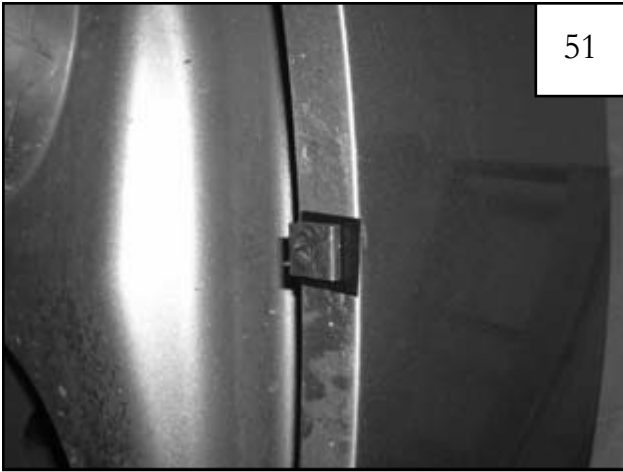

Slide a supplied Clip (CL1-0005) over each Tab. Clips may need to be adjusted to align with holes in flare.



Reposition flare on fender, Start a supplied Screw (SW1-0057) through the two uppermost holes in the flare and into each Clip installed in Step 47.



Start a supplied Screw (SW1-0050) through each of the remaining holes and into each Clip installed in Step 51. If needed, use scratch awl to locate holes.



Completed rear flare installation.