

***advanced FLOW engineering*** Cold Air Intake System

**Instruction Manual** P/N: 50-70007D-1 / 50-70007T-1

Make: Ford Model: Super Duty F-250/F-350/F-450 Year: 2020-2025 Engine: V8-6.7L (td)



- Please read the entire instruction manual before proceeding.
- Ensure all components listed are present.
- For technical support please call 951-493-7185.
- Ensure you have all necessary tools before proceeding.
- Do not attempt to work on your vehicle when the engine is hot.
- Retain factory parts for future use.

Label	Qty.	Description	Part Number
A1	1	Air Filter (Pro 10R)	20-91061
A2	1	Air Filter (Pro DRY S)	21-91061
B	1	Tube	05-5070007B1
C	1	Housing	05-5070007B2
D	1	Coupler, Silicone Bellows	05-01430
E	2	Clamp, #072 (3" - 5")	03-50010
F	1	Seal, Trim	05-01553
G	1	Clamp, T-bolt (8-5/16" - 8-5/8")	03-50267
H	1	Plug, Silicone	05-01429
J	2	Screw, Torx: M4x10mm	03-50490
K	4	Retainer Clip	05-01554
M	1	Fixing Clamp, 3/4"ID	03-50234
N	1	Washer, Flat: M6	03-50070
P	1	Screw, Hex Hd: M6x1x20, Gr 8.8	03-50057
Q	1	Filter Minder Plug	03-50766

**Installation will require the following tools:**

Panel clip remover, T20 Torx driver, 7mm, 8mm & 10mm nut drivers, 7mm socket, 10" extension, 11mm deep socket and driver

**Emissions Disclaimer:** This product is not currently CARB exempt and is not available for purchase in California or for use on any vehicle registered with the California Department of Motor Vehicles.

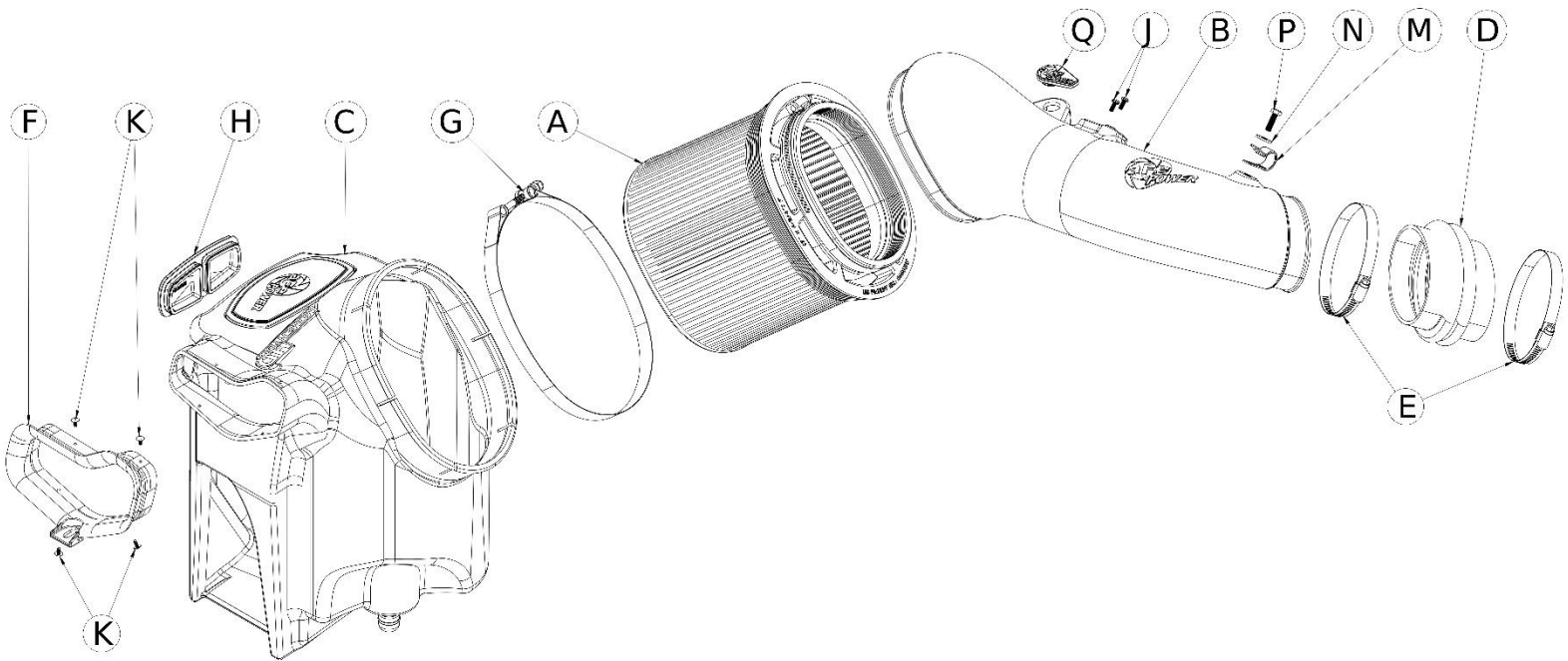

**Figure A****Refer to Figure A for Step 1**

Step 1: Using a 7mm nut driver, loosen the clamps ① at the turbo inlet and the air filter cover. Remove the hose ② from the intake tube clip and remove the intake tube ③.

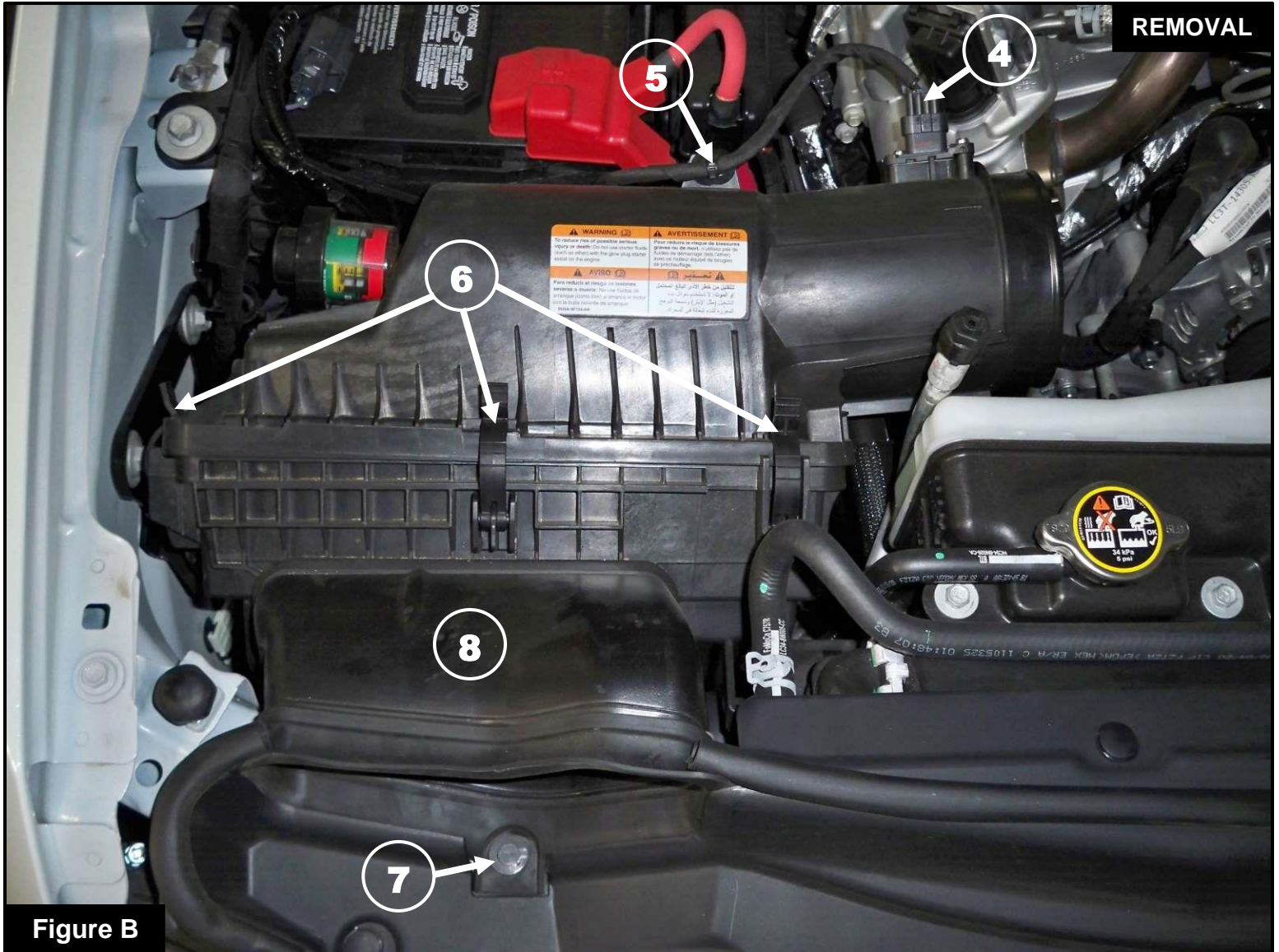

Figure B

**Refer to Figure B for Steps 2-6**

Step 2: Disconnect the MAF sensor (4) and the clip (5) holding the harness.

Step 3: Unclip the three taps (6) from the air filter cover.

Step 4: Remove the air filter cover and air filter.

Step 5: Using a panel clip remover, remove the retaining plastic clip (7) holding part of the scoop seal down and set aside for later use.

Step 6: Snap out the plastic scoop (8) from the air filter housing.



**Refer to Figure C for Steps 7-8**

Step 7: Using a 7mm socket, extension & driver, remove the screw ⑨ holding the air filter housing to the grill inlet duct.

Step 8: Remove the air filter housing by pulling it straight up from its mounting grommets.

**Figure D****Refer to Figure D for Steps 9-10**

Step 9: Place the scoop seal trim ⑩ on the scoop opening of the aFe POWER housing.

Step 10: Align the holes from the scoop seal trim and the aFe POWER housing. Insert all four retainer clips ⑪ fully into the cavities and make sure the seal trim is secure to the aFe POWER housing.

**Figure E****Refer to Figure E for Step 11**

Step 11: Remove the two grommets (12) from the air filter housing and install them onto the aFe POWER housing. Make sure they are fully seated past the bead.

**Figure F****Refer to Figure F for Steps 12-13**

Step 12: Install the aFe POWER housing on to vehicle. Make sure the bottom mounting pin is fully seated in the mounting grommet and the two side mounting pins with grommets are fully engaged on the mounting bracket.

Step 13: Make sure the scoop seal trim seats behind the plastic trim cover (please see picture). Install the retaining plastic clip (13) removed on step 5 to secure the trim seal.

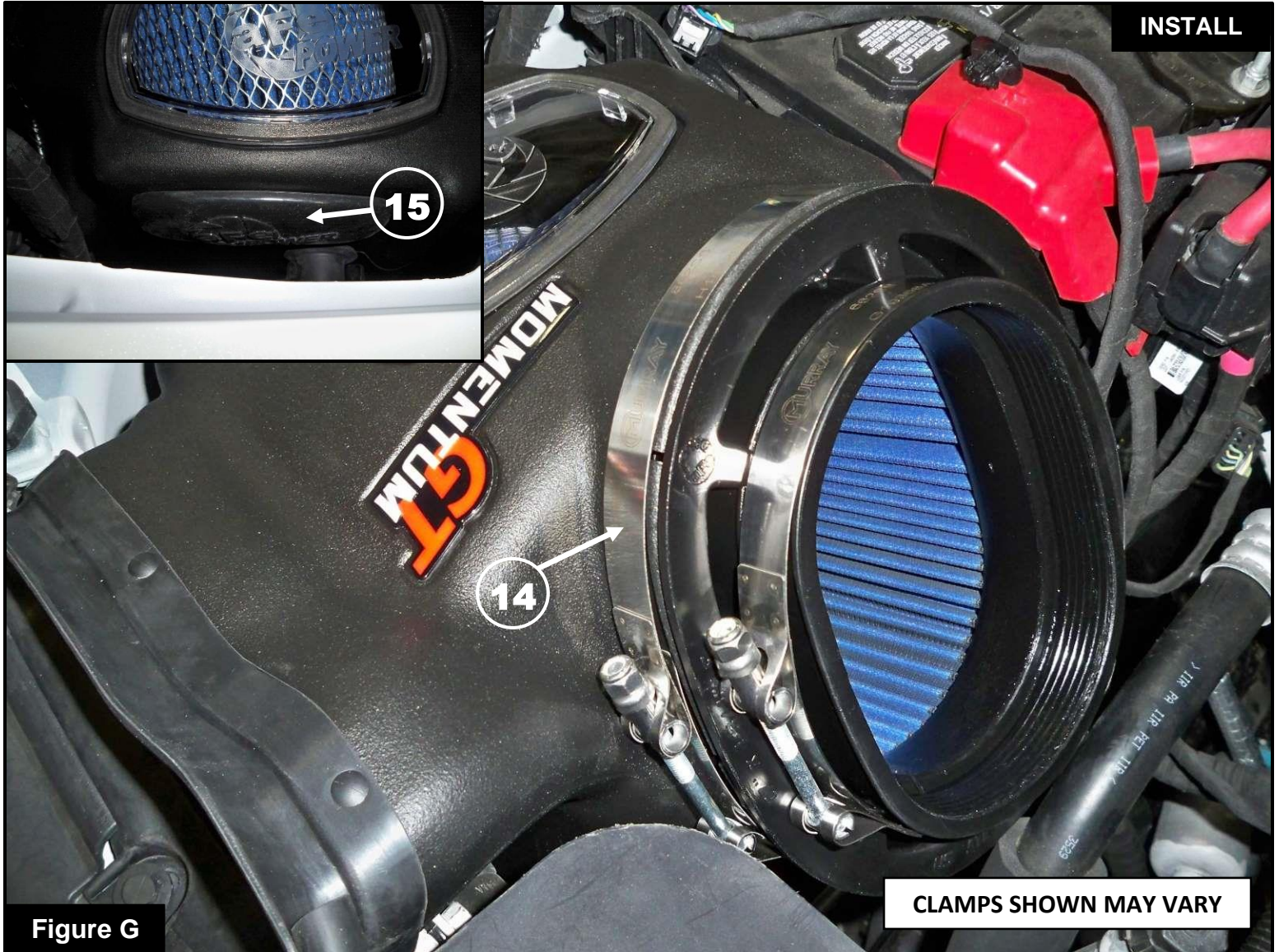

Figure G

**Refer to Figure G for Steps 14-16**

Step 14: Slide the large T-Bolt clamp (14) over the air filter opening on the aFe POWER housing.

Step 15: Slide the aFe POWER filter with clamp into the housing. Do not tighten the clamps.

Step 16: Use the provided plug (15) to close the additional air inlet if you want to completely seal the airbox.

Best performance gain is obtained by having more air flow (no plug).

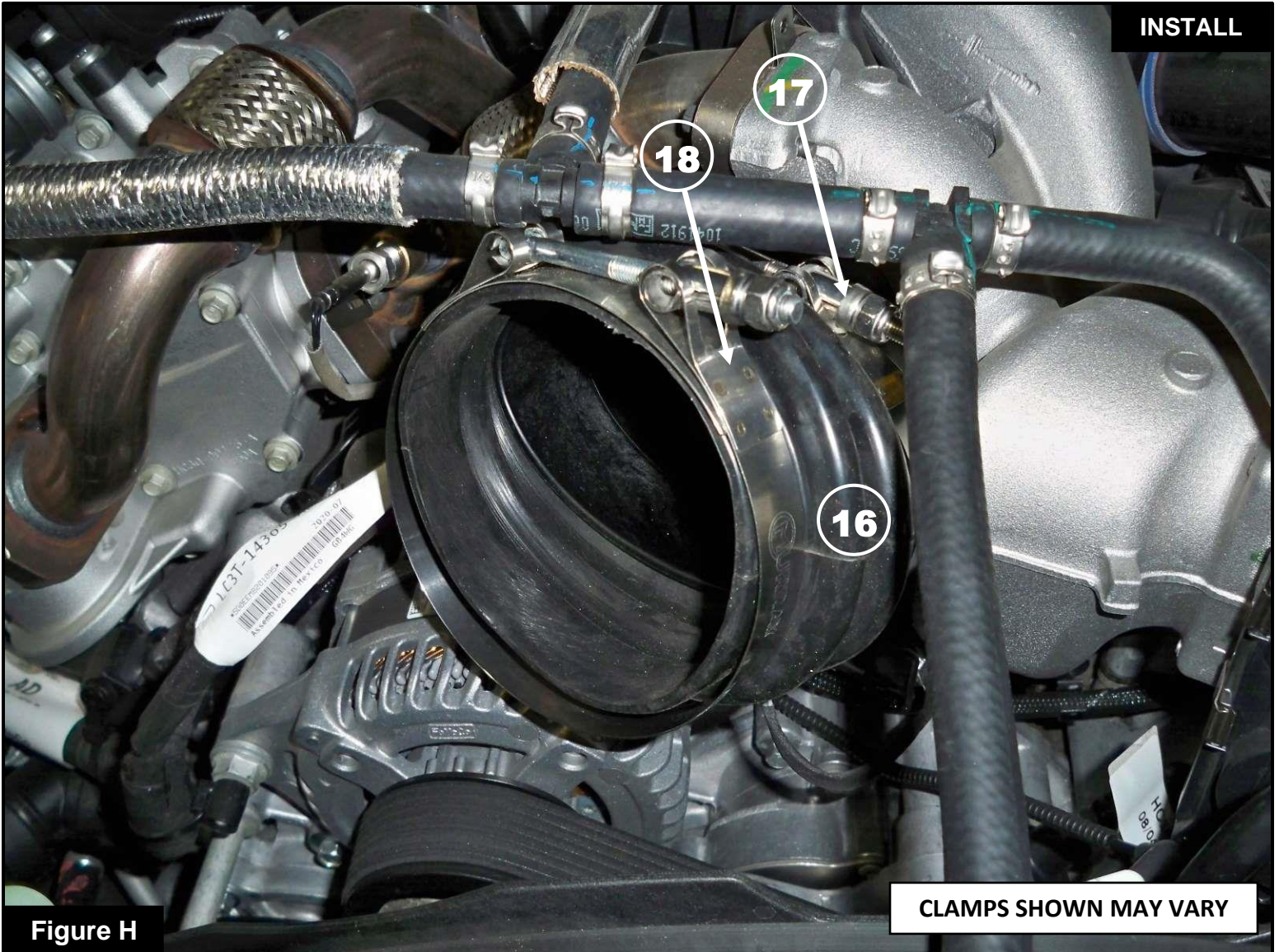
**Figure H****CLAMPS SHOWN MAY VARY****Refer to Figure H for Steps 17-18**

Step 17: Place the supplied aFe POWER coupler (16) and a #72 clamp (17) over the turbo inlet. Do not tighten.

Step 18: Place the other supplied #72 clamp (18) on the installed coupling. Do not tighten.

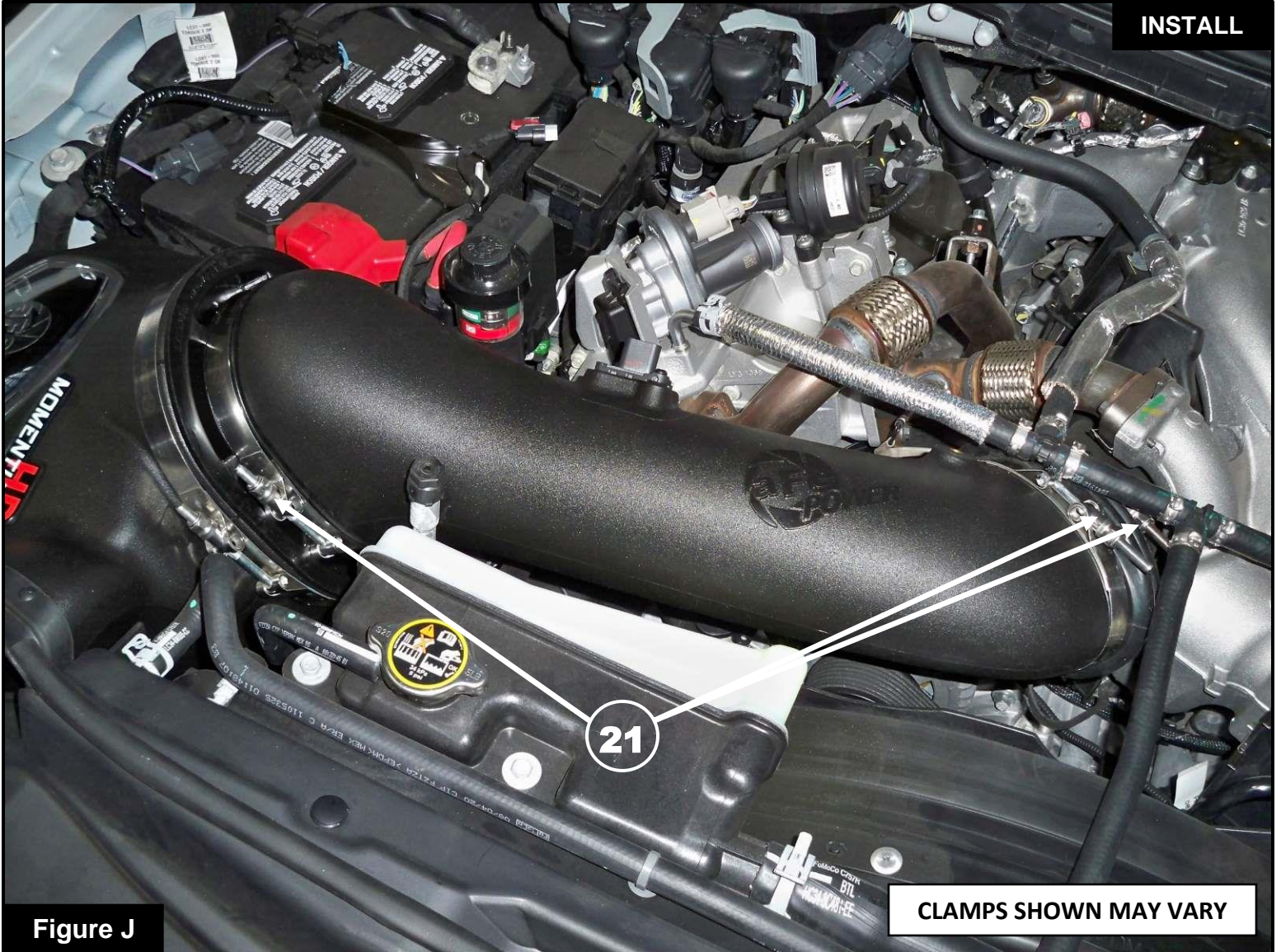

Figure I

**Refer to Figure I for Steps 19-20**

Step 19: Using a T20 Torx driver, remove the MAF sensor (19) from the air filter cover and install it on the aFe POWER intake tube using the supplied M4 screws.

Step 20: Remove the filter minder and grommet (20) from the air filter cover and install them onto the aFe intake tube. If you choose not to use the filter minder or your vehicle does not come with one, then use the provided plug to seal the hole.

**Figure J****CLAMPS SHOWN MAY VARY**

## **Refer to Figure J for Steps 21-22**

Step 21: Install the aFe POWER intake tube into the vehicle. Slide the tube into the throttle body coupler first, then into the air filter.

Step 22: Align the coupler, intake tube and clamps correctly, then using an 8mm nut driver tighten the filter and coupler clamps (21). Using an 11mm deep socket and driver tighten the large T-Bolt clamp.

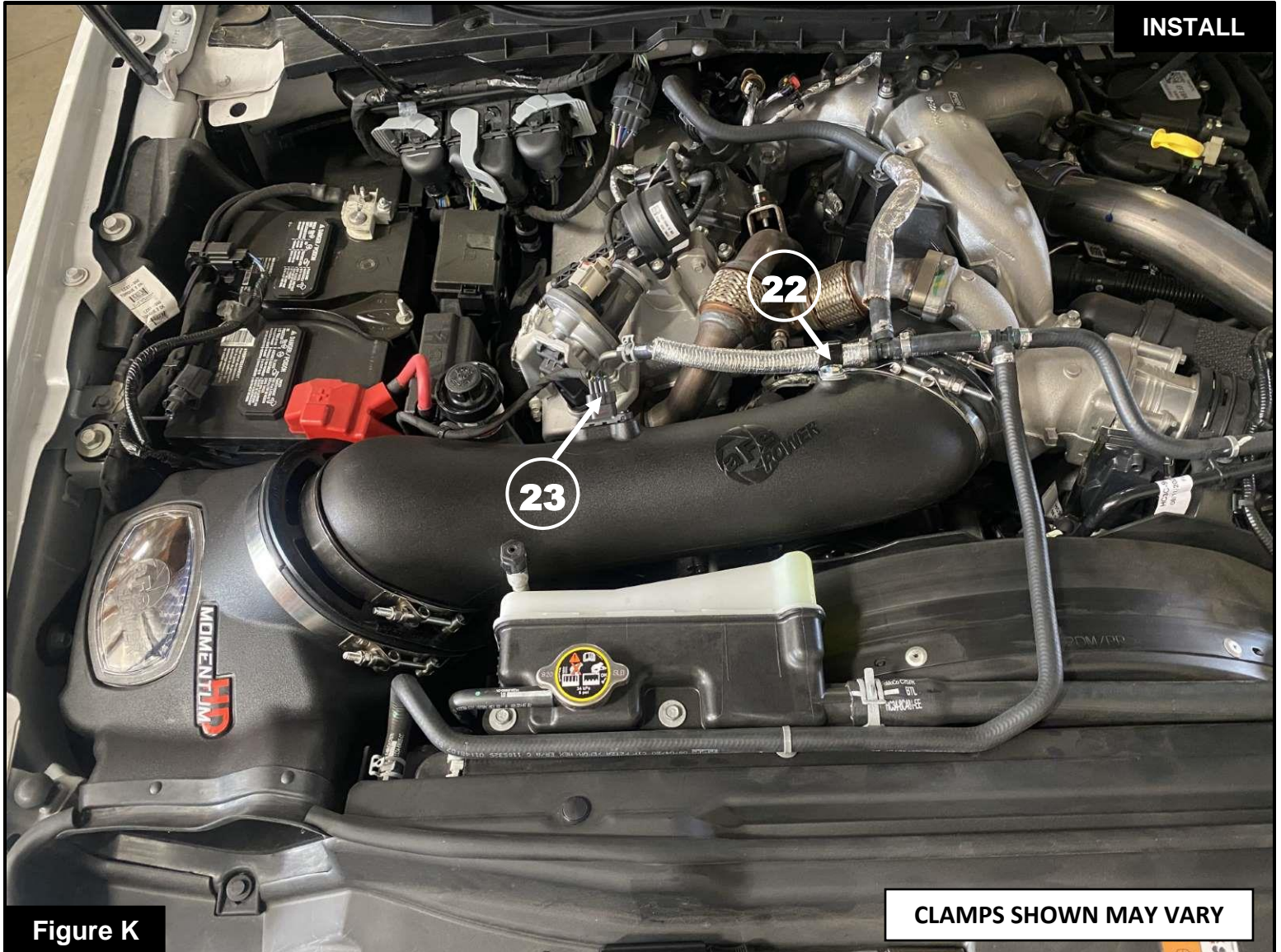

### Refer to Figure K for Steps 23-25

Step 23: Secure the hose to the tube with the provided fixing clamp, 6mm screw and washer (22). Using a 10mm nut driver, tighten the screw.

Step 24: Reconnect the MAF sensor (23).

Step 25: Check all the components are tight and secure. Your installation is now complete. Thank you for choosing aFe POWER!

**NOTE: Check all bolts, clamps, and connectors after 100-200 miles.**



**Page left blank intentionally**

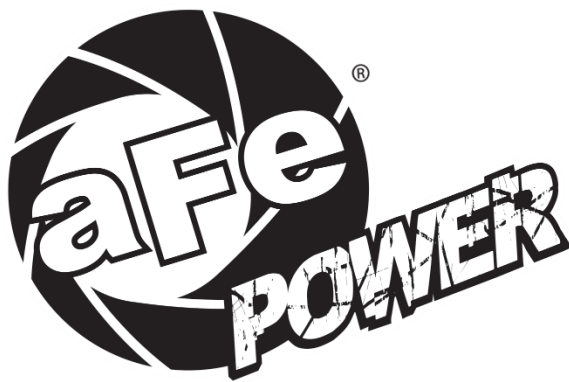

***advanced FLOW engineering, inc.***

Corona, CA 92879

<https://afepower.com/contact>