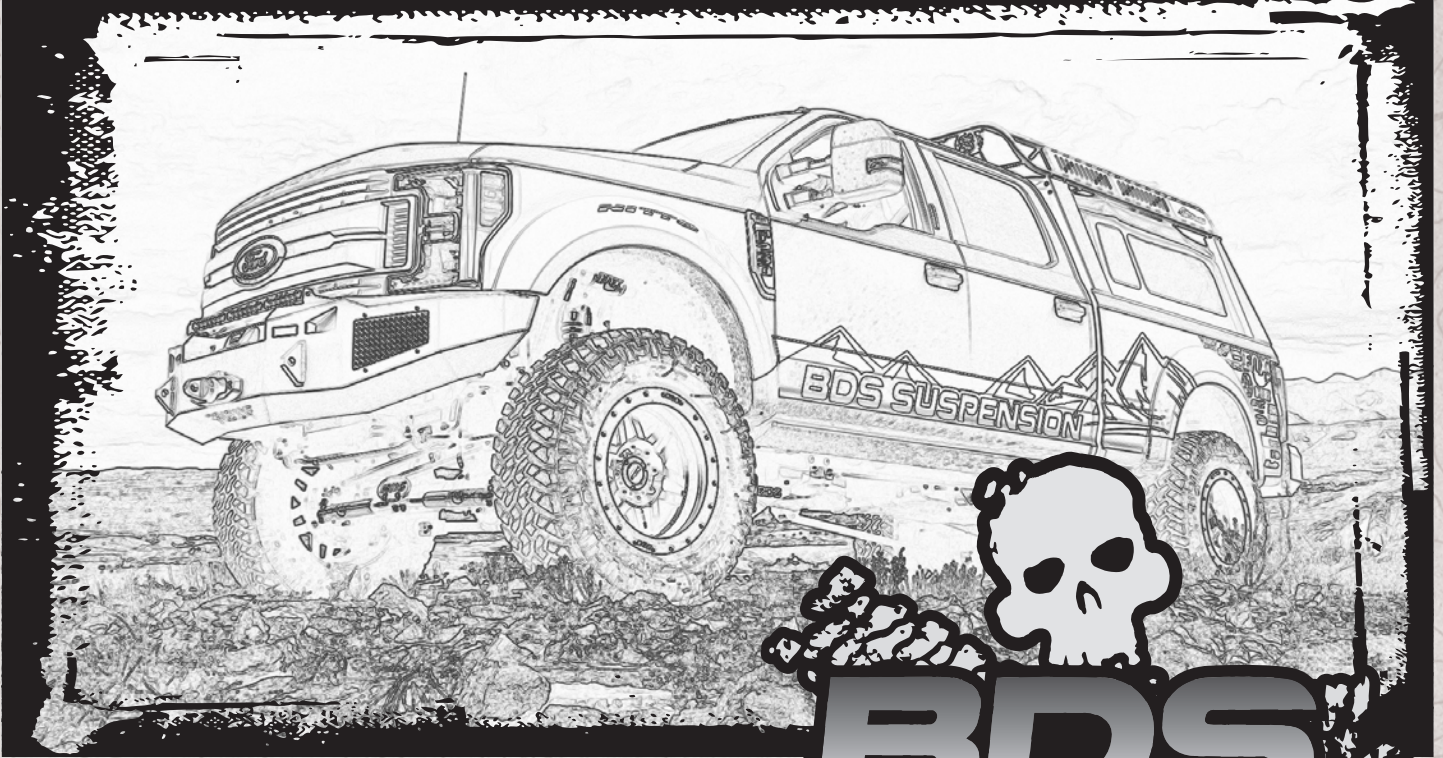


# INSTALLATION GUIDE



Part#: 013602, 013422



**HARDCORE LIMITED LIFETIME WARRANTY**

## 4" & 6" Four Link Suspension System

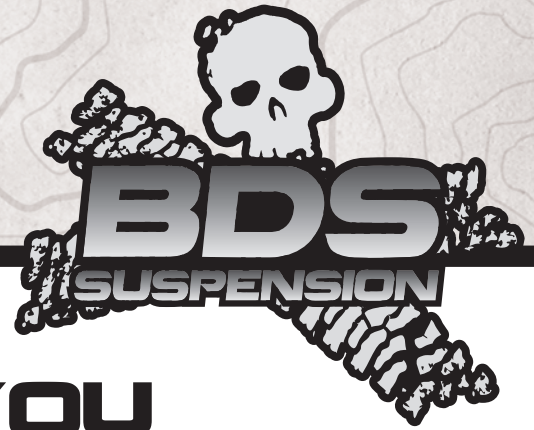
**Ford Super Duty 4WD | 2017-2019**

Rev. 060821

491 W. Garfield Ave., Coldwater, MI 49036 • Phone: 517-279-2135

E-mail: [tech-bds@ridefox.com](mailto:tech-bds@ridefox.com)

# Read And Understand All Instructions And Warnings Prior To Installation Of System And Operation Of Vehicle.



## THANK YOU

Your truck is about to be fitted with the best suspension system on the market today. That means you will be driving the baddest looking truck in the neighborhood, and you'll have the warranty to ensure that it stays that way for years to come.

Thank you for choosing BDS Suspension!

### BEFORE YOU START

BDS Suspension Co. recommends this system be installed by a professional technician. In addition to these instructions, professional knowledge of disassembly/ reassembly procedures and post installation checks must be known.

### FOR YOUR SAFETY

Certain BDS Suspension products are intended to improve off-road performance. Modifying your vehicle for off-road use may result in the vehicle handling differently than a factory equipped vehicle. Extreme care must be used to prevent loss of control or vehicle rollover. Failure to drive your modified vehicle safely may result in serious injury or death. BDS Suspension Co. does not recommend the combined use of suspension lifts, body lifts, or other lifting devices. You should never operate your modified vehicle under the influence of alcohol or drugs. Always drive your modified vehicle at reduced speeds to ensure your ability to control your vehicle under all driving conditions. Always wear your seat belt.

### BEFORE INSTALLATION

- Special literature required: OE Service Manual for model/year of vehicle. Refer to manual for proper disassembly/reassembly procedures of OE and related components.
- Adhere to recommendations when replacement fasteners, retainers and keepers are called out in the OE manual.
- Larger rim and tire combinations may increase leverage on suspension, steering, and related components. When selecting combinations larger than OE, consider the additional stress you could be inducing on the OE and related components.
- Post suspension system vehicles may experience drive line vibrations. Angles may require tuning, slider on shaft may require replacement, shafts may need to be lengthened or trued, and U-joints may need to be replaced.
- Secure and properly block vehicle prior to installation of BDS Suspension components. Always wear safety glasses when using power tools.
- If installation is to be performed without a hoist, BDS Suspension Co. recommends rear alterations first.
- Due to payload options and initial ride height variances, the amount of lift is a base figure. Final ride height dimensions may vary in accordance to original vehicle attitude. Always measure the attitude prior to beginning installation.



Visit [560plus.com](http://560plus.com) for more information.

### TIRES AND WHEELS

Tire: 38x12.50 (6")  
37x12.50 (4")  
Wheel: 9" wide wheel with 4-1/2" Backspacing



### BEFORE YOU DRIVE

Check all fasteners for proper torque. Check to ensure for adequate clearance between all rotating, mobile, fixed, and heated members. Verify clearance between exhaust and brake lines, fuel lines, fuel tank, floor boards and wiring harness. Check steering gear for clearance. Test and inspect brake system.

Perform steering sweep to ensure front brake hoses have adequate slack and do not contact any rotating, mobile or heated members. Inspect rear brake hoses at full extension for adequate slack. Failure to perform hose check/ replacement may result in component failure. Longer replacement hoses, if needed can be purchased from a local parts supplier.

Perform head light check and adjustment.

Re-torque all fasteners after 500 miles. Always inspect fasteners and components during routine servicing.

# CONTENTS OF YOUR KIT

## BDS013601 4 Link Box Kit

Part #	Qty	Description
03420	2	Upper 4-Link Arm
03421	2	Lower 4-Link Arm
985	1	Bolt Pack - 4-link Arm Hardware
	2	<i>M18-2.5 Prevailing Torque Nut - Clear Zinc</i>
	16	<i>3/4 SAE Thru Hard Flat Washer - Clear Zinc</i>
	2	<i>M18-2.5 x 150 Bolt - Class 10.9 - Clear Zinc</i>
	6	<i>3/4"-10 x 5" Bolt - Grade 8 - Clear Zinc</i>
	6	<i>3/4"-10 Prevailing Torque Nut - Clear Zinc</i>
B1198	1	Bag Kit - Upper Arm
60107	2	90 degree grease fitting
7	2	1.0 x 0.120 x 3.25 DOM Sleeve
3527BK	4	Bushing
B1199	1	Bag Kit - Lower Arm
60107	2	90 degree grease fitting
7	2	1.0 x 0.120 x 3.25 DOM Sleeve
3527BK	4	Bushing
03422	4	Cam Lock Plate

## BDS85431 Stabilizer Box Kit

Part #	Qty	Description
15621	1	Stabilizer
SB58BK	2	Bushing - EB1
45313	1	Narrow Sleeve
P00932	1	P Pack - Stabilizer
01504	1	Stabilizer Bracket
561140200RB	2	5/16" x 1-1/4" x 2" Round U-bolt
308	1	Bolt Pack - u-bolts
	4	<i>1/4" USS washer thru hardened</i>
	4	<i>5/16"-18 prevailing torque nut</i>
312	1	Bolt Pack Stabilizer Mounting
	1	<i>3/8"-16 x 2-1/2" bolt grade 5</i>
	1	<i>3/8"-16 prevailing torque nut</i>
	2	<i>3/8" SAE flat washer</i>

## BDS013617 or BDS013438 Replacement Leaf Spring Box Kit

Part #	Qty	Description
583181400SB	4	5/8 x 3-1/8 x 14 U-Bolt (013617 only)
583181100SB	4	5/8 x 3-1/8 x 11 U-Bolt (013438 only)
W78SB	4	7/8 washer
03428	1	E-Brake Relocation Bracket
03429	1	E-Brake Relocation Clamp Bracket
989	1	Bolt Pack - E-Brake Relocation
W58SB	8	5/8 washer
N58FHB	8	5/8 high nut
760400FCP	2	7/16 x 4 Pin w/Nut

## BDS013602 6" Box Kit or BDS 013422 4" Box Kit

Part #	Qty	Description
083404R	1	Pitman Arm
01001	2	Front Bump Stop Extension
03412	1	Track Bar Bracket
01044B	1	Sway Bar Drop - Drv.
01045B	1	Sway Bar Drop - Pass.
03417	1	4-Link Bracket - Drv.
03418	1	4-Link Bracket - Pass.
02449	2	BDS Badge
360	2	Rivet Bolt Packs
02019	2	Track Bar Cam Washer
03473	1	Front Brake Line Bracket (Drv. - 6" Box Kit)
03474	1	Front Brake Line Bracket (Pass. - 6" Box Kit)
03435	2	U-hardline extension (6" Box Kit)
02998	1	Front Brake Line Bracket (Drv. - 4" Box Kit)
02999	1	Front Brake Line Bracket (Pass. - 4" Box Kit)
03419	2	4-Link Bracket Nut Tab
B8130G5	2	M8-1.25 x 130mm Bolt
W56SAE	2	5/16" SAE Flat Washer
099000	4	Zip Tie
6865833	1	Drive Shaft Boot Clamp
65077	1	1/8" x 1-1/4" Cotter Pin
986	1	Bolt Pack - 4-Link Bracket
	2	<i>9/16"-12 x 1-1/2" Bolt - Grade 8 - Clear Zinc</i>
	2	<i>9/16" SAE Thru Hard Flat Washer - Clear Zinc</i>
	4	<i>M12-1.75 x 150mm Bolt - Class 10.9 - Clear Zinc</i>
	4	<i>M12-1.75 Prevailing Torque Nut - Clear Zinc</i>
	8	<i>M12 Flat Washer - Clear Zinc</i>
341	1	Bolt Pack - ABS Wire Clamp (4" Box Kit)
	1	<i>1/4" x 0.28" ID wire coated clamp</i>
	1	<i>1/4"-20 x 3/4" bolt - grade 5</i>
	1	<i>1/4"-20 serrated edge flange nut</i>
	1	<i>1/4" SAE Washer</i>
422	1	Bolt Pack - Sway Bar Drop Bracket
	4	<i>3/8"-16 x 1-1/4" bolt grade 8</i>
	4	<i>3/8"-16 prevailing torque nut</i>
	8	<i>3/8" USS flat washer thru-hardened</i>

## BDS013516 or BDS013517 4" Rear Box Kit

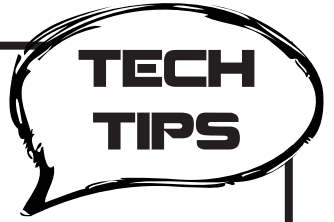
Part #	Qty	Description
03410	1	5" Tapered Superduty Block (DRV)
03411	1	5" Tapered Superduty Block (PASS)
583181900S	4	5/8 x 3-1/8 x 19 Semi-Round U-bolt (013516)
583181600SB	4	5/8 x 3-1/8 x 16 Semi-Round U-bolt (013517)
B218	1	Bag Kit
W58SB	8	5/8" Washer
N58FHB	8	5/8" High Nut

**BDS013607 6" Rear Box Kit**

Part #	Qty	Description
03410	1	5" Tapered Superduty Block (DRV)
03411	1	5" Tapered Superduty Block (PASS)
583181900SB	4	5/8 x 3-1/8 x 19 Semi-Round U-bolt
01015B	2	1" x 3" Bolt on Block
B1195	1	Bag Kit
760600FCP	2	7/16" x 6" Center Pin
W58SB	8	5/8" Washer
N58FHB	8	5/8" High Nut
03428	1	E-Brake Relocation Bracket
03429	1	E-Brake Clamp Bracket
989	1	Bolt Pack -E-Brake Brackets

**BDS013219 6" Rear Box Kit (2-Leaf Main Pack Only)**

Part #	Qty	Description
113219R	2	Add-a-leaf
B1196	1	Bag Kit
105	4	Clamp Sleeve
604	1	Bolt Pack - Clamps
01016	4	Clamp Bracket
1360017	4	Round Anti-Friction Pad

**TROUBLESHOOTING INFORMATION FOR YOUR VEHICLE**

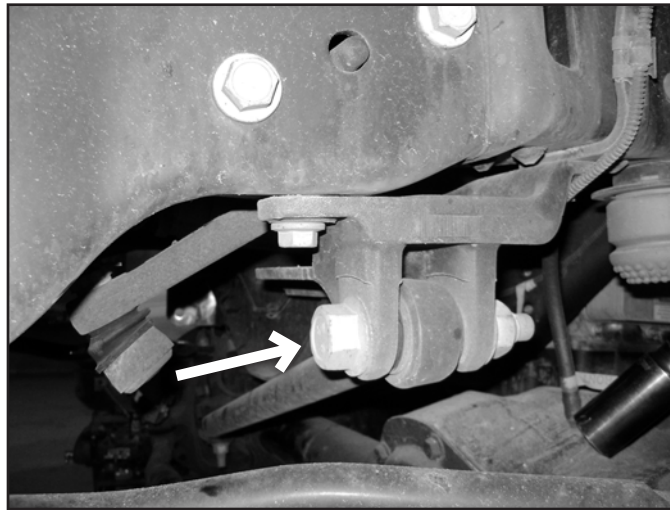
1. Ford recommends replacement of the pitman arm nut after each time it has been removed.
2. Use a small pitman arm puller to remove the drag link joint and steering stabilizer taper.
3. Larger tires on stock wheels are not recommended due to brake line clearance required. Use recommended specifications listed in tire and wheel fitment section.
4. The factory front track bar bolt requires 405 ft-lbs of torque to be installed properly. Be sure you have the means of removing and installing this hardware properly. It is possible to install the hardware and torque to a more modest range (200 ft-lbs or so) and take the vehicle to a shop with the means to torque the hardware properly immediately after the installation is complete.
5. As a result of the location of the long radius arm suspension, support locations are limited. Use your best judgment while supporting the vehicle with sufficient strength stands at appropriate locations. The radius arms will need to move freely during this installation. Recommended to lift the front of the vehicle from the front body mount (An extension may be needed).
6. If replacement leaf springs are install the fuel tank will need to be dropped/ shifted towards the passenger's side of the vehicle. For ease of movement it is recommended to have the fuel tank low on fuel to reduce the weight when moving it.
7. Ensure the proper rear box kit is ordered for either a 2 or 3 leaf factory main pack. See example below of a 2 leaf main pack.

**INSTALLATION INSTRUCTIONS****SPECIAL TOOLS****FRONT INSTALLATION**

1. Park the vehicle on a clean, flat surface and block the rear wheels for safety.
2. Disconnect the front track bar from the frame mount. Retain hardware.

- Large Pitman Arm Puller
- Small Pitman Arm Puller
- 30mm (1-3/16") Socket
- 46mm (1-13/16") Socket
- Large Torque Wrench, ability to torque to 405 ft-lbs.
- CV Boot Clamp Pliers
- Rivet Gun

**FIGURE 1**



3. Raise the front of the vehicle and support under the frame rails with jack stands.



**Tip** *As a result of the location of the long radius arm suspension, support locations are limited. Use your best judgment while supporting the vehicle with sufficient strength stands at appropriate locations. The radius arms will need to move freely during this installation.*

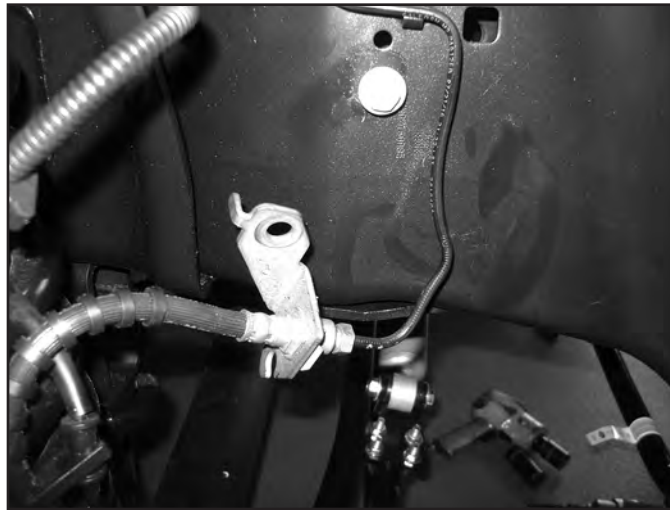
4. Remove the front wheels.
5. Support the front axle with a hydraulic jack.
6. Disconnect the front brake line brackets from the axle (Fig 2). Retain hardware.

**FIGURE 2**



7. Remove the bolts attaching the front brake lines brackets to the frame and save the hardware (Fig. 3). Attempt to not bend the brake lines as much as possible. Remove the ABS line from the brake line bracket.

**FIGURE 3**



8. Free the hub vacuum lines from the axle/ radius arm to allow for adequate droop (Fig. 4A & B).

**FIGURE 4A**



**FIGURE 4B**



9. Disconnect the upper sway bar end links from the sway bar. Push the sway bar up out of the way. Retain hardware.
10. Remove the lower OE shock hardware at this time (leave upper attached). Retain lower mounting hardware.
11. Lower the axle until the OE coil springs are free and remove the springs from the vehicle. Retain the upper spring isolator for use with the new springs. Once coils are removed, reattach the axle to the shocks.

**! Caution** *Do not over extend the brake lines. Once the coil springs are removed, hook the front shocks back up by reinstalling the bolt, do not install the nut. This is a safety measure to hold the axle in place while the replacement radius arms are installed.*

## STEERING

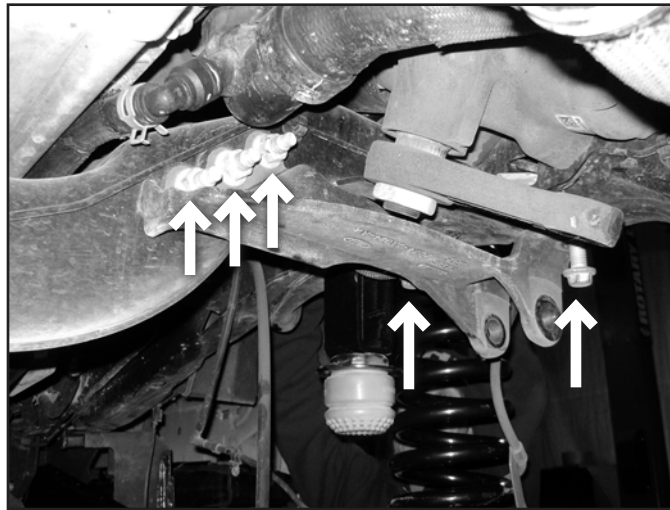
12. Disconnect the OE steering stabilizer from the frame mount. The factory frame mount can be removed or remain on the frame. Disconnect the stabilizer from the factory drag link.



**Tip** *It is easiest to get the taper to break free from the drag link by using a small pitman arm puller. Stock stabilizer will not be reused.*

13. Disconnect the (5) bolts mounting the OE track bar bracket to the frame (Fig. 5). Remove bracket and retain hardware.

**FIGURE 5**



14. Disconnect the steering drag link from the pitman arm. Remove the cotter pin and castellated nut cap. Remove the nut and thread back on by hand a couple turns. Strike the end of the pitman arm near the drag link end to dislodge the taper from the pitman arm (Fig. 6). Remove the nut and the drag link from the pitman arm. Retain hardware.

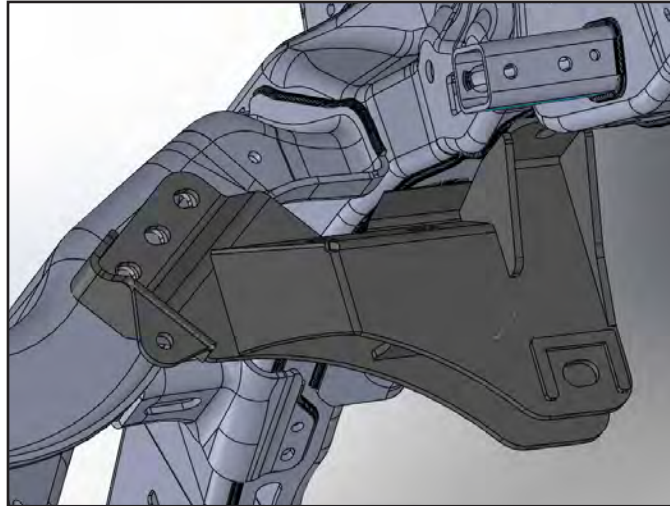
**FIGURE 6**



 **Tip** *The same small pitman arm puller works well.*

15. Remove the pitman arm nut. Note the indexing of the pitman arm in relation to the steering sector shaft and remove the pitman arm from the steering box using the appropriate puller.
16. Remove all of the dry-lock compound on the threads of the pitman arm nut and steering sector shafts. This is important to ensure that the new thread lock compound will adhere properly.
17. Apply a bead of the supplied thread lock all the way around the threads of the pitman arm nut.
18. Install the new pitman arm (indexed the same as the OE) and fasten with the pitman arm nut. Torque the nut to 350 ft-lbs.
19. Install the new track bar bracket (03412) using the stock mounting hardware as it was removed. Torque all (5) mounting bolts to 129 ft-lbs. It may be necessary to form the stock hard line slightly to clear the new track bar bracket. Do not install track bar at this time, it will be installed once the vehicle is on the ground.

**FIGURE 7**



**BUMP STOP MODIFICATION**

20. Pull the OE front bump stops free from the bump stop cups and remove the bolt mounting the cup to the frame.

**FIGURE 8**



21. Position the cup on the provided bump stop extension. (01001) The alignment tab on the bump stop cup will fit in the second hole in the extension
22. Install a provided 8mm x 130mm bolt and 5/16" SAE washer through the cup extension and attach to the frame in the original hole. Use Thread locker on the threads and torque to 20 ft-lbs (Fig 9 A & B).

**FIGURE 9A**



**FIGURE 9B**



**INDEXING RING INSTALLATION (REQUIRED ON 6" LIFT, OPTIONAL ON 4" LIFT)**

23. Refer to the provided instructions in the Indexing Ring Box Kit at this time.

**FOUR LINK INSTALLATION:**

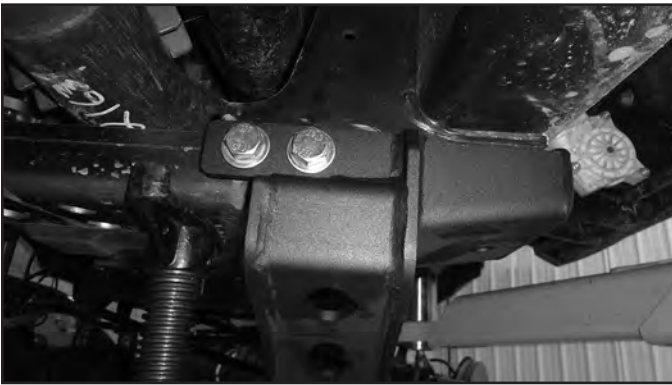
24. Working on one side of the vehicle at a time, loosen the four radius arm-to-axle mounting bolts but do not remove. Once again, ensure that the front axle is well supported and the front drive shaft is disconnected. Failure to disconnect the front drive shaft will damage the front drive shaft CV joint at the transfer case output.
25. Starting with the driver's side, remove the radius arm hardware and save hardware. Remove the radius arm from the vehicle. It may be necessary to remove one of the passenger's side axle bolts to allow the axle to rotate to hook up the four link arm completely.
26. Support the new transfer case cross member and remove the factory 12mm bolts on the driver's side used to support it.  
*Note: If the four link brackets are installed with the factory transfer case cross member on a 4" kit, the transfer case cross member will have to be removed to install the four link brackets. Support the transmission with a jack and block of wood to not damage the oil pan. Remove the (4) 12mm bolts and the center (2) nuts attaching the transfer case isolator.*
27. Install the four link bracket to the factory radius arm bracket on the frame and around the transfer case cross member mounts on the frame. The bracket will mount into the same hole as the factory radius arm. Insert a 3/4" bolt and washer from Bolt Pack 985 through the same hole in the radius arm bracket on the frame and through the four link bracket. Attach using the 3/4" nut and washer, leave hardware loose.  
*Note: The factory hole for the radius arm on the frame may need clearance to fit the 3/4" hardware.*

**FIGURE 10**



28. Install the provided 12mm x 150mm bolts and washer from Bolt Pack 986 through the four link bracket, frame mounts, and the new cross member running the bolts back to front. Attach using the provided 12mm prevailing torque nut and washer to the 12mm bolt. Leave all hardware loose (Fig. 11 A & B).  
*Note: If the four link brackets are installed with the factory transfer case cross member on a 4" kit, install the factory cross member along with the (4) new 12mm hardware.*

**FIGURE 11A**



**FIGURE 11B**



29. Drill a 9/16" hole in the frame through the hole in the side of the four link bracket. Insert the 9/16" x 1-1/2" bolt and washer from Bolt Pack 986 through the hole and attach using the provided 9/16" nut tab. Leave hardware loose.

**FIGURE 12A**



**FIGURE 12B**



30. Lightly grease and install the provided bushings (3527) and sleeves (7) in the four new control arms.
31. Install the provided 90° grease fittings in the threaded holes at the bushing end of the control arms. When installed the fittings should point toward the body of the control arm.
32. Using a 3/4" x 5" bolt and hardware from Bolt Pack 985, install the assembled upper control arm (shorter of the two arms) into the front hole on the factory radius arm bracket (Fig. 13). Install the arm so that the grease fitting is down. *Note: The factory hole for the radius arm on the frame may need clearance to fit the 3/4" hardware.* Attach the upper control arm to the axle using a factory 18mm bolt along with a factory 18mm nut. Leave hardware loose.

*Note: The upper mount on the driver's side factory radius arm will have a captive nut. Use one of the left-over 18mm lower factory nuts for the upper bolt.*

**FIGURE 13**



33. Using a 3/4" x 5" bolt and hardware from Bolt Pack 985, install the lower control arm into the lower hole on the four link bracket. Install the arm so that the grease fitting is up (Fig 14A). Attach the lower control arm to the axle using the provided 18mm x 150mm bolt, 3/4" SAE

washer, 18mm prevailing torque nut and cam plates. Index the cam plates so they are facing towards the rear of the vehicle in the cam slot on the lower control arm. Leave hardware loose (Fig 14B).

**FIGURE 14A**



**FIGURE 14B**



34. Tighten the hardware for **only** the four link bracket (do not tighten the control arms at this time) in the following order: 12mm hardware to 50 ft-lbs, 9/16" hardware to 90 ft-lbs, 3/4" hardware to 150 ft-lbs. The control arm bolts at the frame and axle will be tightened when the vehicle is on the ground.

35. Repeat the frame bracket and control arm installation procedure on the passenger's side of the vehicle.

*Note: If the nuts for the center mounted transfer case isolator are still disconnected from the transfer case cross member, reattach them now and torque to factory specifications.*

### **COIL SPRING INSTALLATION (COILOVER INSTALLATION SEE SEPARATE INSTRUCTION SHEET)**

36. Remove the front shocks from the vehicle completely at this time.

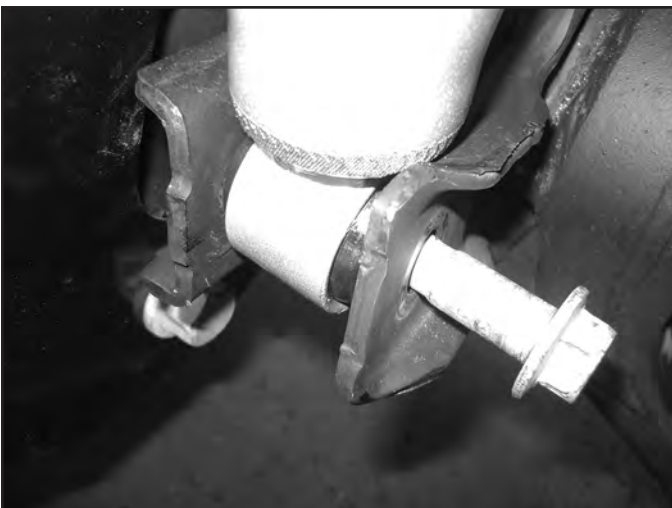
37. Lower the axle enough to allow the coils to be installed. Do not over extend the brake lines. Check ABS, brake, and vacuum lines to ensure they are not overstretched.

38. Install new coils with factory isolators. Rotate the springs so that they seat in the bottom coil perch properly. Raise the axle to seat the coil springs into the correct mounts.

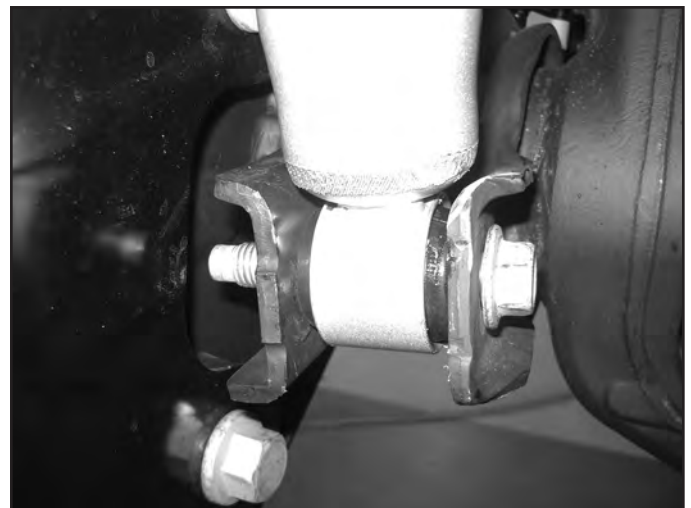
39. Grease and install sleeves and bushings into the shocks.

40. BDS (Silver / non-Fox) shocks will require the lower mount to be modified. The sharp, non-formed edge will need to be ground to match the formed profile. Grind this and coat with paint. (Fig 15a, 15b)

**FIGURE 15A**



**FIGURE 15B**



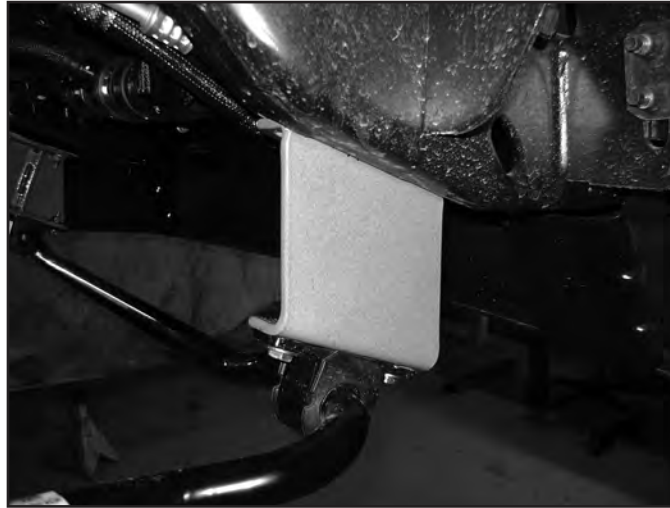
41. Compress the coils slightly by using a hydraulic jack on the axle. Install new shocks with factory lower hardware and stem washers, bushings, and 1/2" fine thread nut on the upper mount. Tighten the upper mount until the bushings begin to swell. Tighten lower mount to 50 ft-lbs.

42. Reattach the factory brake line brackets to the lower coil seat with factory hardware and thread locker at this time.

## SWAY BAR

43. Note the orientation of the front sway bar (top versus bottom). Disconnect the sway bar from the frame and remove from the vehicle. Retain hardware.
44. Install the provided sway bar drop bracket to the original sway bar frame mounting locations with the original hardware. Mount the drop bracket with the open face toward the inside of the vehicle and the bracket offset toward the front. Leave hardware loose.
45. Attach the sway bar to the new drop brackets in the correct orientation with the 3/8" hardware from Bolt Pack #422. Torque the 3/8" and factory hardware to 30 ft-lbs (Fig 16). Center the bolts in the slots in the sway bar drop bracket. The position of the bracket may need to be adjusted for sway bar link to drag link clearance.

**FIGURE 16**



46. Install the sway bar link ends to the sway bar and secure with the OE hardware. Torque to 90 ft-lbs.

## BRAKE LINE / ABS / VACUUM

47. Reattach all vacuum lines. Use provided zip ties where needed. (4" Kit skip to step 56)
48. Install the provided brake line brackets with the factory hardware. The driver's side will be a straight drop (Fig. 17A) and the passenger's side will be angled back towards the rear of the vehicle (Fig. 17B).

**FIGURE 17A**



**FIGURE 17B**



49. Remove the clip holding the brake line to the factory bracket. Save the clip for later installation.
50. **Warning:** The next three steps must be performed quickly to ensure minimal brake fluid loss. Un-thread the factory soft brake line from the hard brake line.
51. Remove the factory brake line bracket from the brake line. Discard the bracket it will not be reused.
52. Thread the provided U-brake line with the union first onto the factory hard brake line, followed by threading the U-brake line onto the factory soft brake line. Check to make sure all connections are tight and no brake fluid is leaking.

53. Attach the factory soft brake line to the brake line bracket on the frame with the clip removed in the previous step. The brake line should be facing down towards the axle.

*Note: The factory soft brake line may need to be rotated so that it will line up with the notches on the new brake line bracket on the frame. Break free the U-brake line from the soft line and rotate as needed.*

54. Make sure the brake lines are close to the frame in order to provide clearance to the tires, but are not rubbing on the frame. The brake line junctions can be loosened and turned to provide clearance where needed (Fig. 17C & D).

**FIGURE 17C**



**FIGURE 17D**



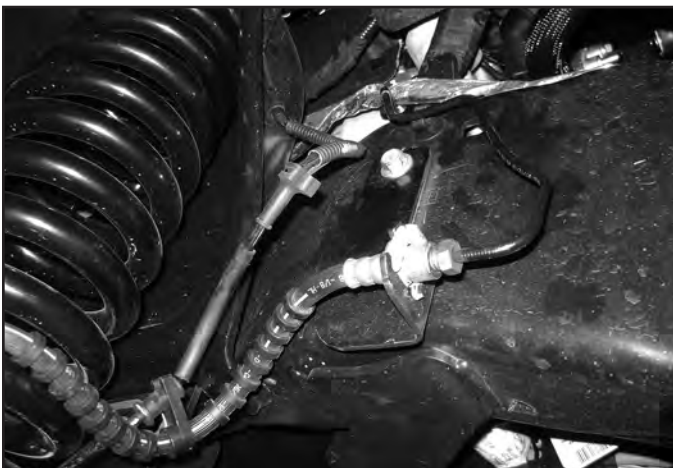
55. Attach the ABS wire to the new brake line bracket. The rubber grommet may need to be slid up the ABS line, use silicone spray to help aid in moving the rubber grommet.

**FIGURE 18**

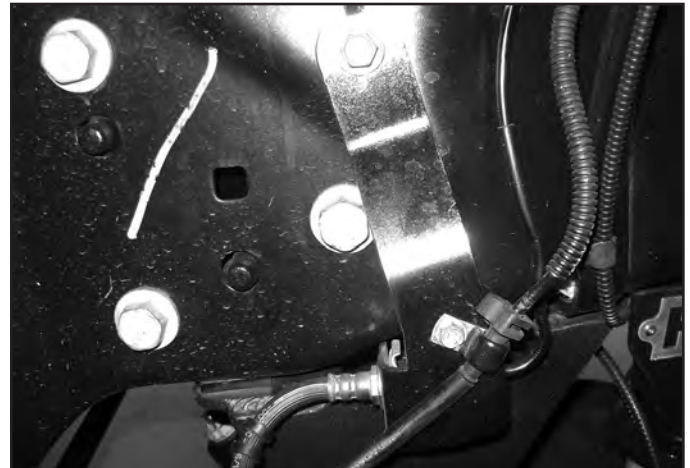


56. **4" Kit Only:** Install the new brake line brackets, the brackets are side specific. Brake lines will need to be reformed to reach the new mounting position. It may be necessary to slightly twist the brake line fittings in relation to the hard line to get adequate clearance to the frame / wheel and tire. Attach the ABS wire to the driver's side with 1/4" hardware and cable clamp in Bolt Pack 341 (Fig 19A, 19B)

**FIGURE 19A**



**FIGURE 19B**



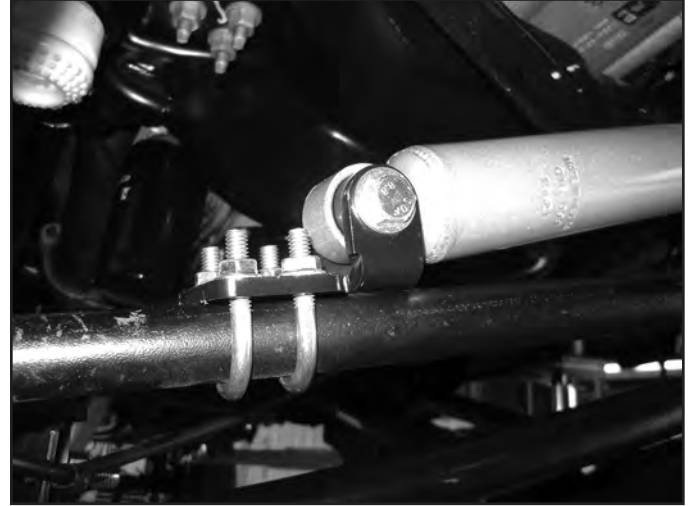
## STEERING STABILIZER

57. Reattach the steering drag link to the pitman arm. Torque nut to 148 ft-lbs. Install the original castellated nut cap and new 1/8" cotter pin.
58. Skip this step if a dual steering stabilizer will be used. Center the steering wheel. Extend the steering stabilizer 4-1/2" to 4-3/4" and attach to the frame end with stud pack in the stabilizer box kit. Attach stabilizer bracket to the drag link with the included u-bolts, washers, and nuts. Attach stabilizer to bracket with 3/8" hardware. Tighten 5/16" hardware to 15 ft-lbs, 3/8" to 35 ft-lbs, 7/16" Stud nut to 45 ft-lbs, and 1/2" stud nut to 65 ft-lbs. (Fig 20 A & B)

**FIGURE 20A**

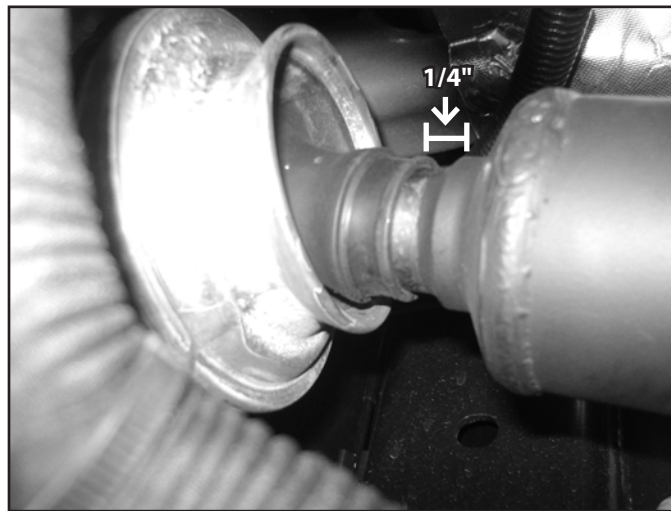


**FIGURE 20B**



59. Properly bleed the brake system of air and top off the brake fluid reservoir with the proper type of fluid (see owners manual).
60. Remove the factory CV joint clamp at the front transfer case output on the drive shaft. Slide the end of the boot up approximately 1/4" and re-clamp with new CV joint boot clamp. Use the CV Boot Clamp Pliers to compress the CV joint boot clamp to the front drive shaft (Fig 21).
61. Reattach the front drive shaft to the front differential with factory hardware. Tighten to 55 ft-lbs.

**FIGURE 21**



62. Install the front wheels and lower the vehicle to the ground. Torque lug nuts to 165 ft-lbs.
63. Attach the track bar to the new bracket with the OE hardware. Turn the steering wheels to aid in aligning the track bar in the bracket. Install the provided cam washers between the alignment tabs on the bracket. Position the cam washers so that the hole is closer to the driver's side for 4" kits. (Figure 22) The hole should be closer to the passenger's side for 6" kits. Torque hardware to 406 ft-lbs.



**Tip** Due to variations in trucks, it may be necessary to rotate the cams 180 degrees to have the axle more centered.

**FIGURE 22 - 4" OFFSET TOWARDS DRIVER'S SIDE**



64. If an indexing ring was installed, follow these instructions for the transfer case skid plate installation. Install the transfer case skid plate drop bracket on the driver side using the factory hardware into the J-nut in the frame. The bracket should be slanted towards the rear of the vehicle. Attach the transfer case skid plate to the J-nuts in the frame on the passenger side using the factory hardware. Attach the transfer case skid plate to the drop bracket on the driver's side using the 3/8" hardware from Bolt Pack 987 in the Indexing Ring kit. Torque to 20 ft-lbs (Figure 23).

**FIGURE 23**



65. Bounce the front of the vehicle to settle the suspension. Torque all four link hardware to 220 ft-lbs.
66. The badge can now be riveted on to the 4-link brackets using the provided 1/8" rivets. Any residue on the badge can be cleaned up using alcohol or brake cleaner before install. With the badge not installed it can be painted to what ever color you desire, or left raw as a stainless steel badge.
67. Check all hardware for proper torque.

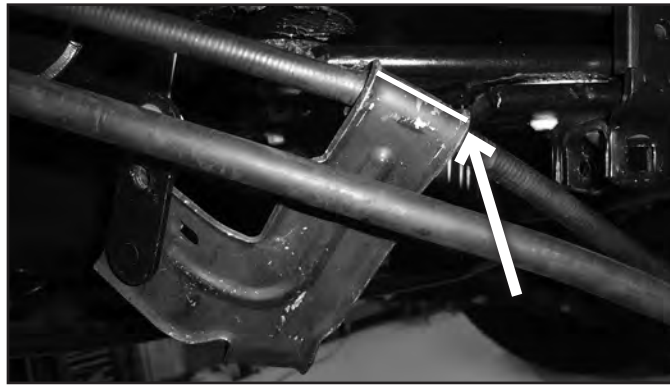
## **REAR INSTALLATION**

68. Block the front wheels for safety.
69. Raise the rear of the vehicle and support with jack stands under the frame rails just ahead of the spring hangers.
70. Remove the wheels.
71. Support the axle with a hydraulic jack.
72. Remove the OE shocks. Retain all mounting hardware.

## **E-BRAKE CABLE RELOCATION PART 1 (4" REPLACEMENT LEAF SPRINGS AND ALL 6" KITS)**

73. Gain slack from the E-Brake cable on the driver's side. It is easiest to pull on the cable and use a pair of vise grips to hold the cable, be careful not to damage the cable.
74. Cut the bracket for the E-brake cable that is going to the passenger side of the vehicle in order to release the cable from the bracket. See Figure 24 for which bracket and where to cut. It is easiest to cut most of the way through the steel and then bend the flange up to release the cable from the bracket. Be careful not to cut the E-brake cable!

**FIGURE 24**



75. Depress the tabs and remove the passenger side E-brake cable from the mount on the frame.
76. Once the passenger side E-brake cable is free, remove the bolt and J-nut attaching the bracket to the frame.
77. Remove the driver side E-brake cable from the bracket and discard the bracket and hardware.
78. Remove the bolt and J-nut for smaller E-brake cable bracket. The E-brake cable relocation bracket will be reinstalled after the new leaf springs are installed.

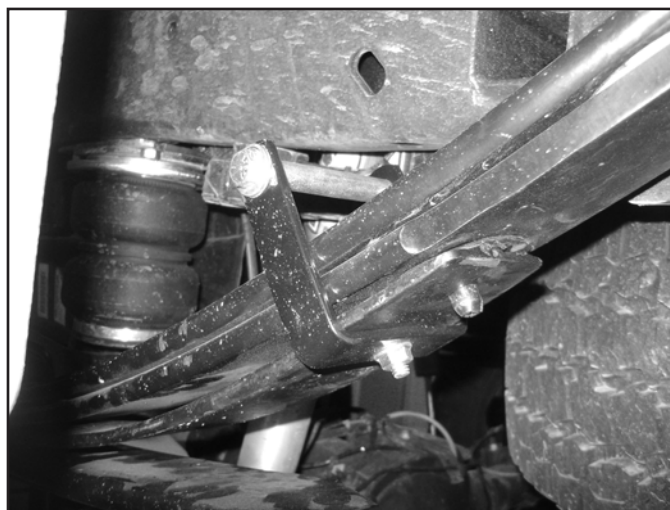
**4" AND 6" BLOCK KIT ONLY**

79. Disconnect the passenger's side spring u-bolts. Loosen the driver's side to allow the axle to droop out.
80. Lower the axle and remove the factory lift block. It will not be reused.  
*Note: 4" Kits skip ahead to rear block installation.*
81. Clamp the main leaf pack together with C-Clamps. Remove the center pin nut and center pin.
82. All springs when completed will have 3 main leaves, lower overload, and 1" bolt on block below the overload. Certain springs may have top mounted overloads, the center pin provided will only work for single top mounted overloads with a 1" spacer block in between. Variations from this will require custom center pins, or a 7/16" x 7" socket head cap screw can be substituted in place of a center pin.

**2 MAIN LEAF FACTORY LEAF PACK ONLY (6" KIT ONLY)**

83. Install the Hendricks clamps onto the add-a-leaf to the bottom side of the leaf spring using the 5/16" countersunk bolt and nut from Bolt Pack 604. Install the anti-friction pads into the add-a-leaf.

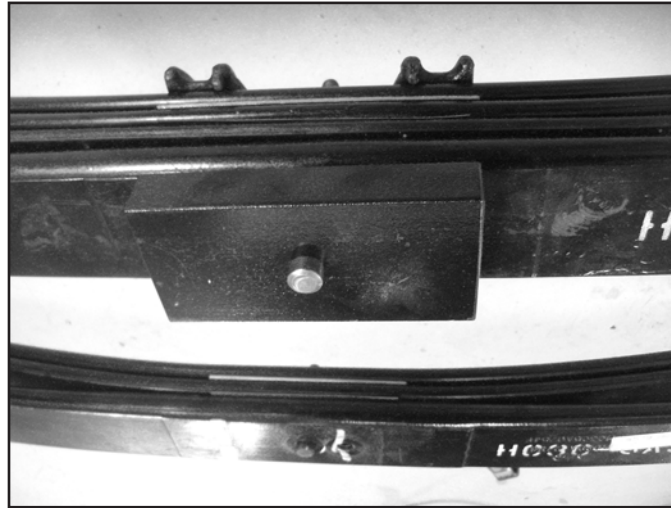
**FIGURE 25**



84. Allow the C-Clamps to expand. Remove the locating dowel that holds the overload to the bottom main spring. Discard the locating dowel it will not be reused.  
*Note: The locating dowel will be discarded and will NOT go into the add-a-leaf.*

85. Install the add-a-leaf below the main leaf pack and above the overload. The add-a-leaf has 2 holes in it. Position add-a-leaf so there is 22" between the center pin hole and the front, and 23" to the rear from the center pin hole.
86. Assemble the leaf spring as shown. Use the 1" bolt on block, overload, add-a-leaf, main leaf pack, and top mounted overload springs if equipped (not shown), and upper u-bolt plate. Tighten center pin nut to 20 ft-lbs.

**FIGURE 26**



87. Install the sleeve to the Hendricks clamp using the provided 3/8" hardware from Bolt Pack 604.

### **3 MAIN LEAF FACTORY LEAF PACK ONLY (6" KIT ONLY)**

88. Allow the C-Clamps to expand. Remove the center pin.
89. Attach 1" bolt on block to the bottom of the main leaf pack with new center pin. Tighten to 20 ft-lbs. See Fig 21 above.

### **REAR BLOCK INSTALLATION**

90. Lower the axle enough to place the provided 5" lift block between the axle and the leaf spring (Figure 27). Position the block so the bump stop wing faces inward, and the small side of the block faces forward. (03410 - Drivers side, 03411 - Pass side)

**FIGURE 27**



91. Raise the axle to engage the block spring alignment pins. Fasten the entire assembly with the provided u-bolts, washers, and nuts. Snug but do not torque the u-bolts at this time.

**FIGURE 28**

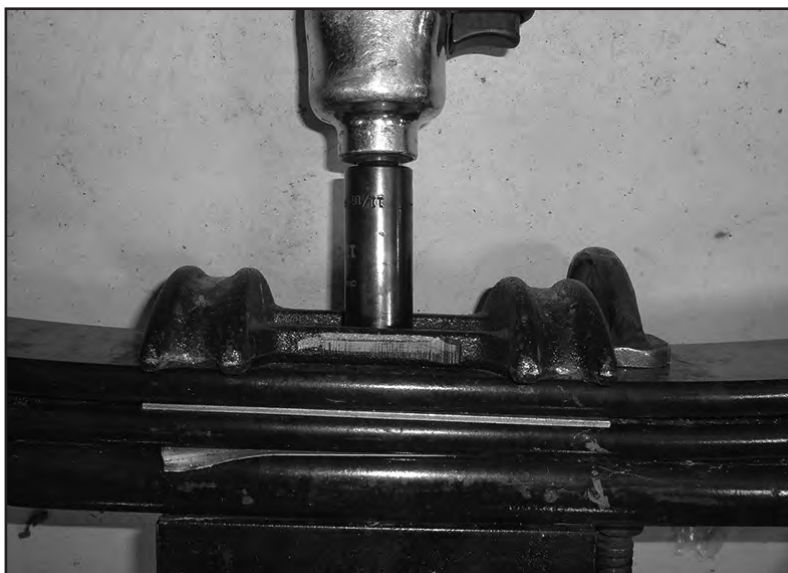


92. Repeat block installation of the driver's side. Take care not to over extend the brake lines.

**REPLACEMENT REAR LEAF SPRING KIT ONLY (4" & 6" KITS)**

93. Disconnect the passenger's side u-bolts and lower the axle from the spring.
94. 4" Kits ONLY: Discard OE block, spring will install directly to the axle.
95. 6" Kits ONLY: Retain OE block to be installed with new spring.
96. Loosen and remove the front spring-to-frame and rear shackle-to-frame bolts and remove the spring from the vehicle. *Note: When installing the driver's side leaf spring the fuel tank may have to be shifted towards the passenger's side of the vehicle to remove the front spring-to-frame bolt. Support the fuel tank and loosen the bolts for the fuel tank hanger. Shift the fuel tank towards the passenger's side of the vehicle to remove the leaf spring bolt.*
97. Remove the shackle from the OE spring and loosely install it on the new rear spring. Be sure that the shackle is oriented on the new spring identical to the old. The shackles mount of the longer end of the spring (opposite of the end marked with "FRT").
98. Using a pair of clamps, clamp the top and bottom of the factory leaf next to the OE upper U-bolt mount. Remove the OE upper U-bolt mount from the center pin on the top of the OE leaf spring in order to be installed on the new spring. Reassemble the OE leaf spring with the OE center pin and remove the clamps (Figure 29).

**FIGURE 29**



99. The OE upper U-bolt mount will be installed on the new leaf springs. Clamp the top and bottom of the new leaf springs near the center pin, but still allowing enough room to install the OE upper U-bolt mount. Remove the center pin from the new leaf springs and attach the OE upper U-bolt mount to the new leaf springs with the center pin. A pair of new center pins are provided incase the center pins in the new leaf springs strip out.

**FIGURE 30**



100. Install the new spring in the vehicle with the OE bolts. Use the provided 7/8" SAE Washers as spacers for the front leaf spring bushing (use one on each side of the leaf spring bushing. Leave hardware loose. All of the spring pivot bolts will be torqued with the weight of the vehicle on the springs.
101. 6" Kit Only: Remove all dirt and corrosion from the axle spring pad and raise the axle to the spring with the OE block while aligning the center pins with the center pin holes. The wing on the OE block will point in towards the center of the vehicle. Fasten the spring with the provided u-bolts, 5/8" washers, 5/8" high nut, and OE lower u-bolt plate. Snug but do not torque u-bolts at this time. *Note: The U-bolts may need to be cut shorter for the socket to tighten the nuts*
102. 4" Kit Only: Remove all dirt and corrosion from the axle spring pad and raise the axle to the spring while aligning the center pins with the center pin holes. Fasten the spring with the provided u-bolts, 5/8" washers, 5/8" high nut, and OE lower u-bolt plate. Snug but do not torque u-bolts at this time. *Note: The U-bolts may need to be cut shorter for the socket to tighten the nuts*
103. Repeat the procedure on the driver's side. Take care not to over extend the brake lines.

**E-BRAKE CABLE RELOCATION PART 2 (4" REPLACEMENT LEAF SPRINGS AND ALL 6" KITS)**

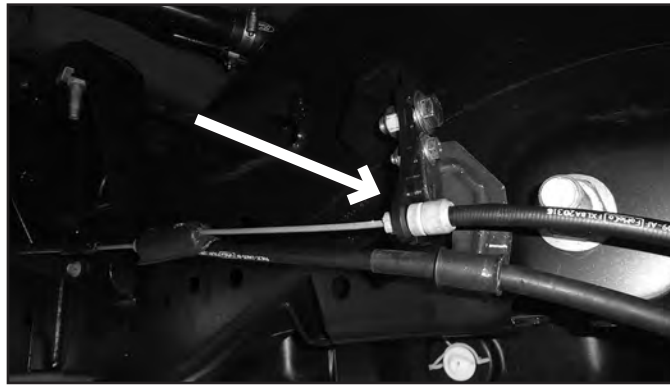
104. Install the new E-brake cable bracket with the provided 1/2" hardware and 5/16" hardware from bolt pack 989 as shown in Figure 39. The smaller driver side E-brake cable bracket will be installed in the same position as it was from the factory, but attached with the 5/16" hardware (Figure 31).

**FIGURE 31**



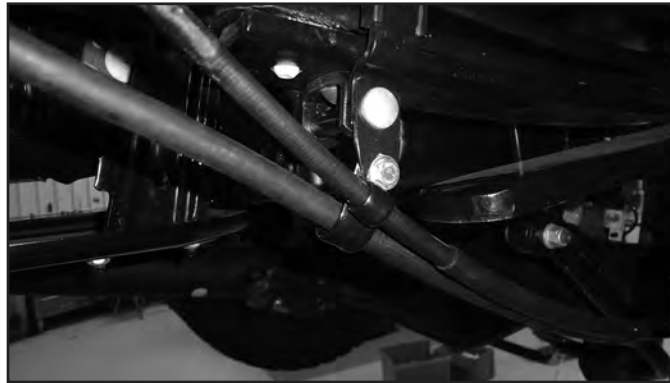
105. Install the passenger side E-brake cable into the bracket, make sure the tabs on the cable lock the cable into place.

**FIGURE 32**



106. Remove the 3/8" bolt on the front leaf springs clamp. Install the E-brake clamp bracket with the new provided 3/8" bolt and nut from bolt pack 998 through the leaf spring clamp. Make sure the E-brake clamp bracket is towards the outside of the leaf spring. Tighten the 3/8" hardware with the spacer tube in between to 25 ft-lbs.

**FIGURE 33**



107. Use the two provided wire clips from bolt pack 989 to secure both E-brake cables to the E-brake clamp bracket with the provided 5/16" hardware from bolt pack 989 (Figure 33).

## **ALL REAR KITS**

108. Install the new shocks with the original mounting hardware.
109. Install wheels and lower the vehicle to the ground.
110. With the weight of the vehicle on the axle, torque the U-bolts to 130-150 ft-lbs.
111. If replacement leaf springs were installed, torque all of the leaf spring hardware to factory specifications.
112. Check all hardware for proper torque.

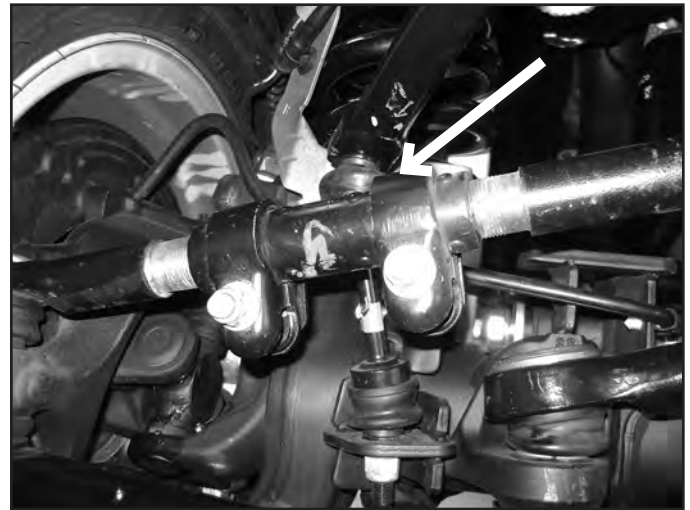
## **POST INSTALLATION**

113. Cycle steering to check for brake line, ABS wire, ETC to tire clearance, rotate the driver's side brake line on the hard line if necessary.
114. Adjust steering wheel with adjustment on the drag link, do NOT drive the vehicle with the steering wheel off-center or adverse traction control affects may arise. Rotate the clamps once the steering wheel is straight as shown. (Fig 30A - incorrect, clamps will interfere with sway bar, Fig 30B - correct clearance)
115. An alignment is recommended, but not necessary. BDS recommends running caster at or above the maximum specification for improved handling / driving purposes.
116. Adjust headlights
117. Be sure the brake system has been properly bled and the brake fluid is topped off.
118. Check all hardware for proper torque. Check hardware after 500 miles.

**FIGURE 34A \*INCORRECT\***



**FIGURE 34B \*CORRECT\***



**WE WANT TO SEE YOUR RIDE!**

Grab photos of your BDS-equipped truck in action and send them in for a chance to be featured. Send it in to our Bad Ass Rides customer gallery at [bds-suspension.com/bar](http://bds-suspension.com/bar) and post them on the BDS Fan Page on Facebook at [facebook.com/BDSSuspensions](https://facebook.com/BDSSuspensions). Don't forget about your BDS swag! BDS offers t-shirts, hoodies, decals and more available on the BDS website or through your local BDS distributor.

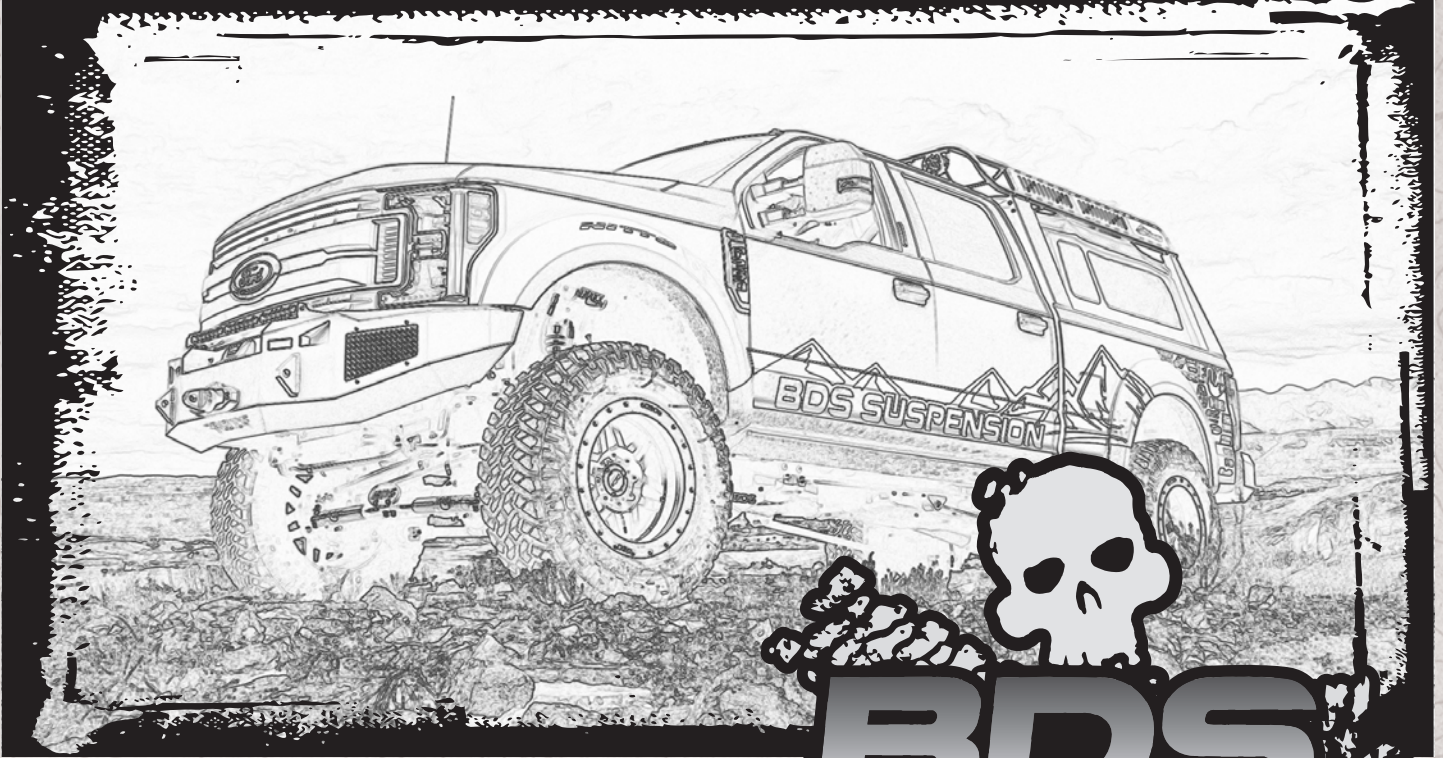
---

**TIME TO HAVE SOME FUN**

**Thank you for choosing BDS Suspension.**

For questions, technical support and warranty issues relating to this BDS Suspension product, please contact your distributor/installer before contacting BDS Suspension directly.

# INSTALLATION GUIDE



Part#: 123613



**HARDCORE LIMITED LIFETIME WARRANTY**

## Coilover Installation Instructions

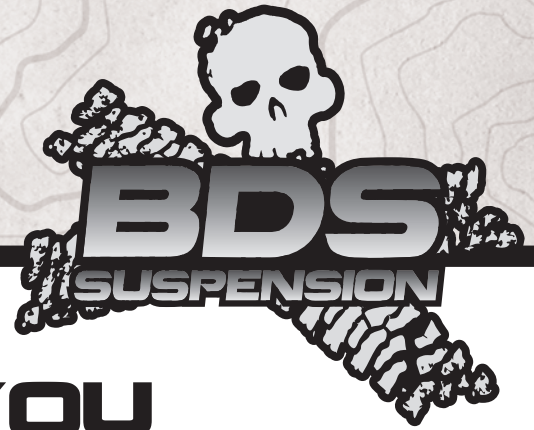
**Ford F-250 & F-350 Superduty 4WD | 2017-2022**

Rev. 031122

491 W. Garfield Ave., Coldwater, MI 49036 • Phone: 517-279-2135

E-mail: [tech-bds@sporttruckusainc.com](mailto:tech-bds@sporttruckusainc.com)

# Read And Understand All Instructions And Warnings Prior To Installation Of System And Operation Of Vehicle.



## THANK YOU

Your truck is about to be fitted with the best suspension system on the market today. That means you will be driving the baddest looking truck in the neighborhood, and you'll have the warranty to ensure that it stays that way for years to come.

Thank you for choosing BDS Suspension!

### BEFORE YOU START

BDS Suspension Co. recommends this system be installed by a professional technician. In addition to these instructions, professional knowledge of disassembly/ reassembly procedures and post installation checks must be known.

### FOR YOUR SAFETY

Certain BDS Suspension products are intended to improve off-road performance. Modifying your vehicle for off-road use may result in the vehicle handling differently than a factory equipped vehicle. Extreme care must be used to prevent loss of control or vehicle rollover. Failure to drive your modified vehicle safely may result in serious injury or death. BDS Suspension Co. does not recommend the combined use of suspension lifts, body lifts, or other lifting devices. You should never operate your modified vehicle under the influence of alcohol or drugs. Always drive your modified vehicle at reduced speeds to ensure your ability to control your vehicle under all driving conditions. Always wear your seat belt.

### BEFORE INSTALLATION

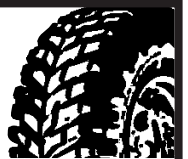
- Special literature required: OE Service Manual for model/year of vehicle. Refer to manual for proper disassembly/reassembly procedures of OE and related components.
- Adhere to recommendations when replacement fasteners, retainers and keepers are called out in the OE manual.
- Larger rim and tire combinations may increase leverage on suspension, steering, and related components. When selecting combinations larger than OE, consider the additional stress you could be inducing on the OE and related components.
- Post suspension system vehicles may experience drive line vibrations. Angles may require tuning, slider on shaft may require replacement, shafts may need to be lengthened or trued, and U-joints may need to be replaced.
- Secure and properly block vehicle prior to installation of BDS Suspension components. Always wear safety glasses when using power tools.
- If installation is to be performed without a hoist, BDS Suspension Co. recommends rear alterations first.
- Due to payload options and initial ride height variances, the amount of lift is a base figure. Final ride height dimensions may vary in accordance to original vehicle attitude. Always measure the attitude prior to beginning installation.



Visit [560plus.com](http://560plus.com) for more information.

### TIRES AND WHEELS

4-1/2" backspace wheels with 12.50 width tire are recommended for tire to reservoir hose clearance. Stock wheels are not recommended.



### BEFORE YOU DRIVE

Check all fasteners for proper torque. Check to ensure for adequate clearance between all rotating, mobile, fixed, and heated members. Verify clearance between exhaust and brake lines, fuel lines, fuel tank, floor boards and wiring harness. Check steering gear for clearance. Test and inspect brake system.

Perform steering sweep to ensure front brake hoses have adequate slack and do not contact any rotating, mobile or heated members. Inspect rear brake hoses at full extension for adequate slack. Failure to perform hose check/ replacement may result in component failure. Longer replacement hoses, if needed can be purchased from a local parts supplier.

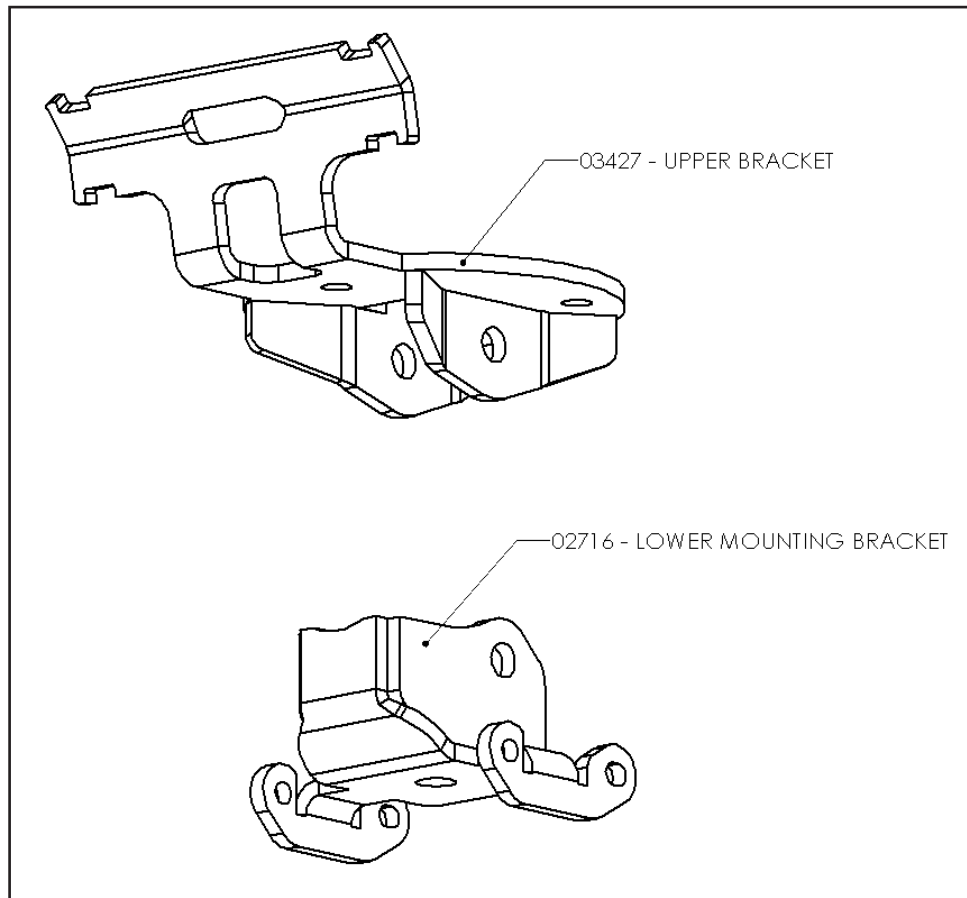
Perform head light check and adjustment.

Re-torque all fasteners after 500 miles. Always inspect fasteners and components during routine servicing.

# CONTENTS OF YOUR KIT

Box Kit		
Part #	Qty	Description
02716	2	Lower Coilover Mount
03427	2	Upper Coilover Mounting Bracket
	6	Zip Tie
2296	2	2" Bump Stop (2.5" Kit)
953	1	Bolt Pack
	2	14mm-2.00 x 30mm Bolt
	2	14mm Flat Washer
	2	7/16" Clamp w/ 0.281 Hole
	4	1/4"-20 x 3/4" Bolt
	4	1/4"-20 Nylock Nut
	8	1/4" SAE Washer
	4	#10-24 x 3/4" Machine Screw
	4	#10-24 Serrated Edge Flanged Nut
	4	#10 SAE Washer

Box Kit		
Part #	Qty	Description
988	1	Bolt Pack
	4	1/2"-13 x 2-3/4" Bolt
	8	1/2" SAE Washer
	4	1/2"-13 Prevailing Torque Nut
	6	7/16"-14 x 1-1/4" Bolt
	12	7/16" SAE Washer
	6	7/16"-14 Prevailing Torque Nut
	2	8mm-1.25 x 70mm Bolt
	4	5/16" USS Washer



## TECH TIPS

### TROUBLESHOOTING INFORMATION FOR YOUR VEHICLE

1. This is only the installation instructions for installation of the coilover shocks and mounting brackets, does not include the installation instructions for any other applicable kit components which must be purchased separately.
2. Stock wheels and tires are not recommended due to factory offset

## INSTALLATION INSTRUCTIONS

### INSTALLATION INSTRUCTIONS

1. Park vehicle on clean, flat, and level surface.
2. Raise front of vehicle and support frame rails with jack stands.
3. Remove the front wheels.
4. Support the front axle with a hydraulic jack.
5. Disconnect the sway bar links from the sway bar, this will allow the axle to droop out enough. (Fig 1)

### SPECIAL TOOLS

Sawzall with long blade  
Drill

**FIGURE 1**



6. Remove the front shocks, retain lower shock hardware.

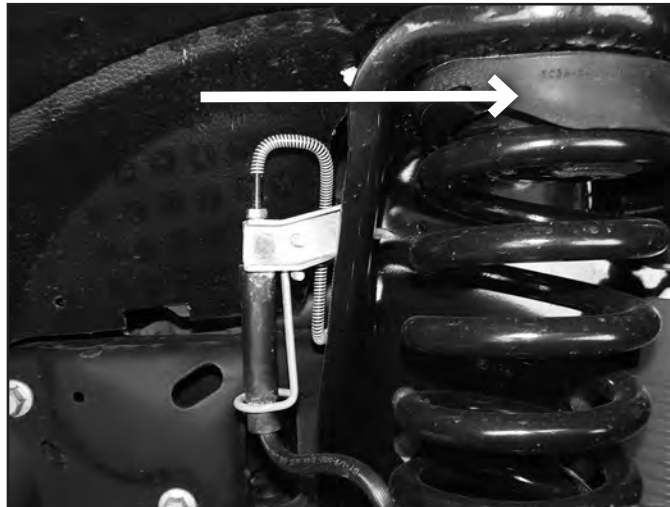
7. Disconnect the brake line bracket from the factory lower coil seat (Fig 2). Disconnect the ABS lines from the backside of the lower coil seat.

**FIGURE 2**



8. Lower the axle and remove the factory coil springs and upper coil spring isolator. Take care not to over extend any brake, ABS, or vacuum lines. (Fig 3)

**FIGURE 3**



9. Remove the lower coil spring seat from the top of the axle, it will not be reinstated.

## UPPER COIL BUCKET MODIFICATION

10. Trim the upper coil spring centering tube from the factory mount with a sawzall. Ensure the cut is flush with the mounting surface. (Fig 4a, 4b)

**FIGURE 4A**



**FIGURE 4B**



11. Disconnect the module from the driver's side coil bucket (attached in 3 places), may not be present on all model years / engine configurations. Move the module up so that it is not damaged when the holes are drilled.
12. The cable tie mount on the passenger side will need to be bent up in order to clear the upper coilover mount. First remove the cable tie from the mount and then bend the mount up so that it is at least 3/8" above the bottom side of the coil bucket. After the cable tie mount is bent up, reconnect the cable tie to the mount.

**FIGURE 5A**

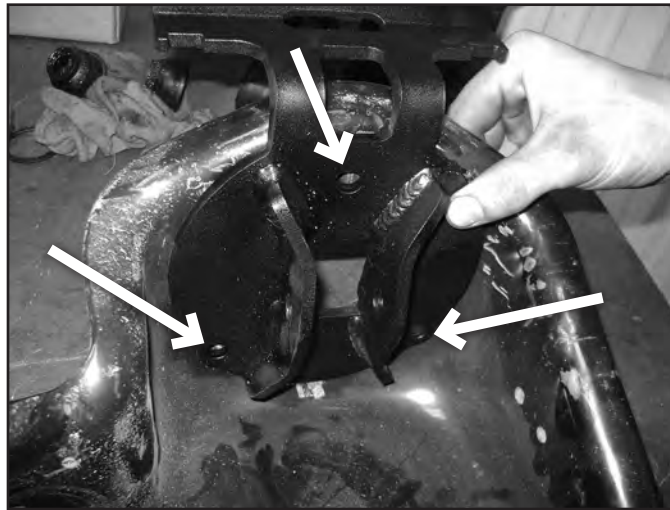


**FIGURE 5B**



13. Place the upper coilover mounting bracket up to the upper mount. Rotate the bracket so that the reservoir bracket is parallel with the frame. (Fig 6)

**FIGURE 6**



14. Mark the center of the holes, remove bracket, and drill out to 15/32" to 1/2". Make sure the drill does not damage the module on the driver's side (not present on all model year trucks).!

*NOTE: On the passenger side, ensure that the wire harness behind the wheel well liner will not be pinched by the reservoir bracket. The liner may need to be removed to allow the wire harness to be reformed.*

15. Install the bracket with 7/16" hardware, run the bolts from top-down. Do NOT tighten at this time, the mount needs to be loose to install the upper coilover hardware. Thread the nuts on by hand a couple of turns to hold the bracket in place. (Fig 7)

**FIGURE 7**



16. Install the lower bracket with new 14mm bolt (#953). Tighten to 75 ft-lbs.
17. Install the coilover into the upper mounting bracket with 1/2" x 2-3/4" bolt (#988). Coilovers are marked side specific. Bolt is a tight squeeze to fit into the bracket and between the stock bracket. It may be necessary to loosen the upper mount more to allow the bolt to fit into the mounting bracket.
18. Attach the coilover to the lower mounting bracket with 1/2" x 2-3/4" hardware (#988).
19. Tighten all coilover and mounting bracket hardware at this time. 7/16" hardware: 45 ft-lbs, 1/2" 65 ft-lbs.
20. Attach the reservoir to the mounting bracket with the included hose clamps. Rotate the reservoir so that the hose is pointed slightly 'inward' for extra tire clearance. (Fig 8)

**FIGURE 8**



**BUMP STOP INSTALLATION**

21. Remove the factory bump stop, remove the factory hardware that attaches the cup to the frame.
22. Make sure the bump stop extension is installed in conjunction with the lift system. Damage to the coilover or other parts may result from not installing the bump stop extension.
23. 2.5" Kit Only: Install the provided bump stop spacer in this kit (2" tall for 2.5" kits) and factory bump stop cup with the 8mm x 70mm bolt and 5/16" USS Washer from Bolt Pack 988. Tighten to 25 ft-lbs. Reinstall the factory bump stop into the bump stop cup. (Fig 9)

**FIGURE 9 (2.5" KIT ONLY)**



24. Attach the front axle lines to the new lower bracket with included 1/4" hardware. Aftermarket brake lines will use the included wire clamp (shown in figure). Additional zip ties are included to retain any ABS / vacuum lines if necessary. (Fig 10) The ABS wire will attach with #10 hardware from bolt pack #953.

**FIGURE 10**



25. Install optional auxiliary shock in factory position with factory hardware if desired.
26. Continue with lift kit installation at this time. If the coilover system is being installed as an upgrade to a current lift system, follow the instructions below.
27. Reattach sway bar links to sway bar. Reinstall wheels.
28. Cycle steering at full droop and check for adequate clearances
29. Lower vehicle to the ground and torque lug nuts to factory specification. Cycle steering to check for adequate clearances.
30. Recheck all hardware for proper torque, recheck again after 500 miles.



## **WE WANT TO SEE YOUR RIDE!**

Grab photos of your BDS-equipped truck in action and send them in for a chance to be featured. Send it in to our Bad Ass Rides customer gallery at [bds-suspension.com/bar](http://bds-suspension.com/bar) and post them on the BDS Fan Page on Facebook at [facebook.com/BDSSuspensions](https://facebook.com/BDSSuspensions). Don't forget about your BDS swag! BDS offers t-shirts, hoodies, decals and more available on the BDS website or through your local BDS distributor.

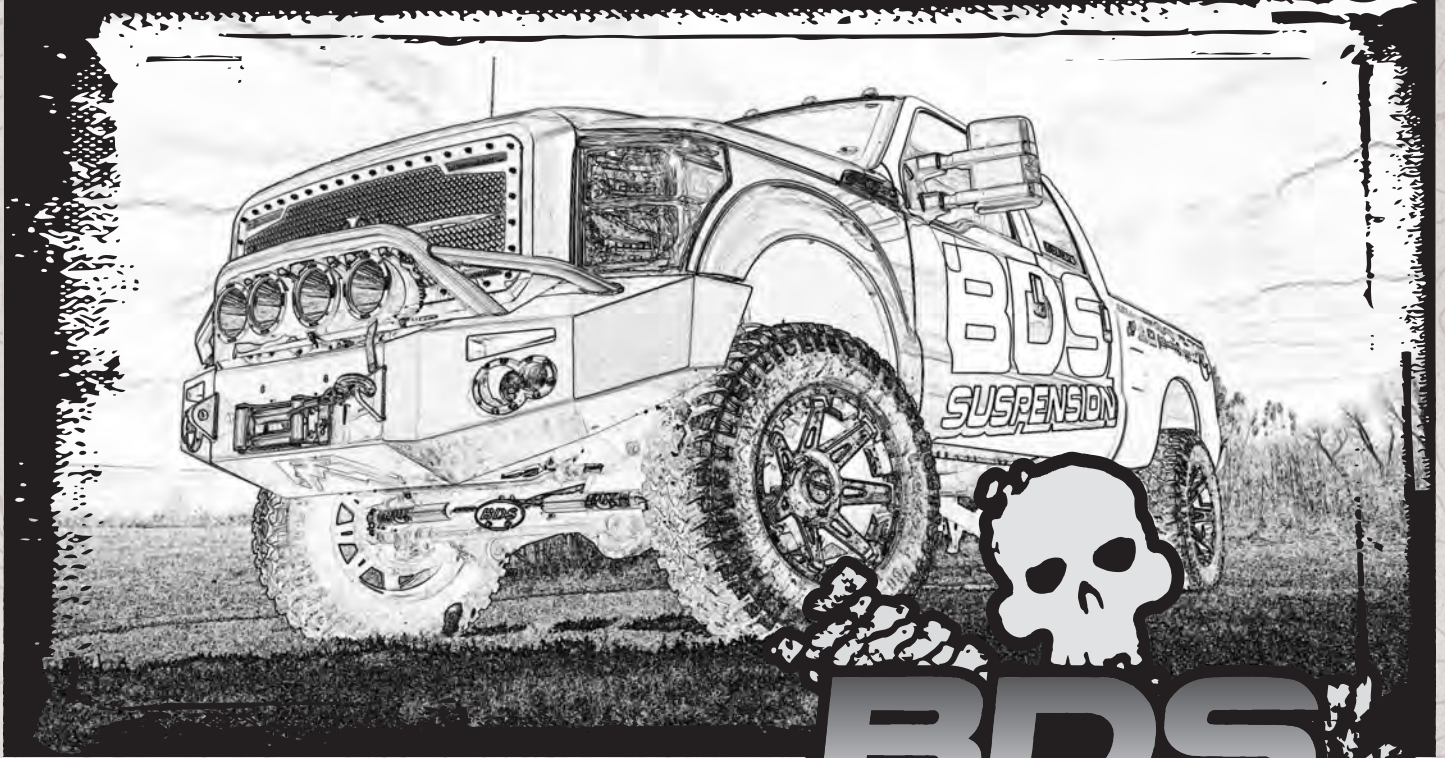
---

## **TIME TO HAVE SOME FUN**

**Thank you for choosing BDS Suspension.**

For questions, technical support and warranty issues relating to this BDS Suspension product, please contact your distributor/installer before contacting BDS Suspension directly.

# INSTALLATION GUIDE



Part#: 123605, 123615



**HARDCORE LIMITED LIFETIME WARRANTY**

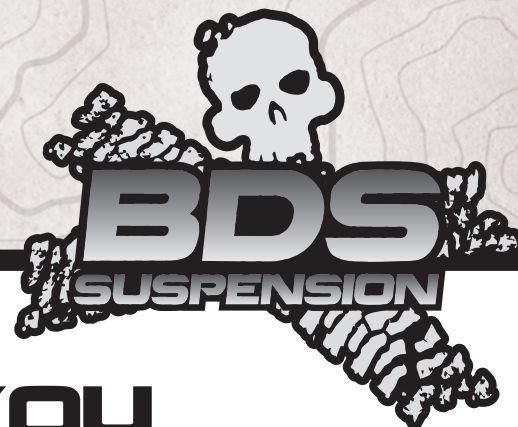
## Transfer Case Indexing Ring Kit

Ford Super Duty 4WD- Diesel | 2017-19  
Ford Super Duty 4WD- 10 Speed | 2020-21

Rev. 060920

491 W. Garfield Ave., Coldwater, MI 49036 • Phone: 517-279-2135  
E-mail: [tech-bds@ridefox.com](mailto:tech-bds@ridefox.com)

# Read And Understand All Instructions And Warnings Prior To Installation Of System And Operation Of Vehicle.



## THANK YOU

Your truck is about to be fitted with the best suspension system on the market today. That means you will be driving the baddest looking truck in the neighborhood, and you'll have the warranty to ensure that it stays that way for years to come.

Thank you for choosing BDS Suspension!

### BEFORE YOU START

BDS Suspension Co. recommends this system be installed by a professional technician. In addition to these instructions, professional knowledge of disassembly/ reassembly procedures and post installation checks must be known.

### FOR YOUR SAFETY

Certain BDS Suspension products are intended to improve off-road performance. Modifying your vehicle for off-road use may result in the vehicle handling differently than a factory equipped vehicle. Extreme care must be used to prevent loss of control or vehicle rollover. Failure to drive your modified vehicle safely may result in serious injury or death. BDS Suspension Co. does not recommend the combined use of suspension lifts, body lifts, or other lifting devices. You should never operate your modified vehicle under the influence of alcohol or drugs. Always drive your modified vehicle at reduced speeds to ensure your ability to control your vehicle under all driving conditions. Always wear your seat belt.

### BEFORE INSTALLATION

- Special literature required: OE Service Manual for model/year of vehicle. Refer to manual for proper disassembly/reassembly procedures of OE and related components.
- Adhere to recommendations when replacement fasteners, retainers and keepers are called out in the OE manual.
- Larger rim and tire combinations may increase leverage on suspension, steering, and related components. When selecting combinations larger than OE, consider the additional stress you could be inducing on the OE and related components.
- Post suspension system vehicles may experience drive line vibrations. Angles may require tuning, slider on shaft may require replacement, shafts may need to be lengthened or trued, and U-joints may need to be replaced.
- Secure and properly block vehicle prior to installation of BDS Suspension components. Always wear safety glasses when using power tools.
- If installation is to be performed without a hoist, BDS Suspension Co. recommends rear alterations first.
- Due to payload options and initial ride height variances, the amount of lift is a base figure. Final ride height dimensions may vary in accordance to original vehicle attitude. Always measure the attitude prior to beginning installation.



Visit [560plus.com](http://560plus.com) for more information.

### BEFORE YOU DRIVE

Check all fasteners for proper torque. Check to ensure for adequate clearance between all rotating, mobile, fixed, and heated members. Verify clearance between exhaust and brake lines, fuel lines, fuel tank, floor boards and wiring harness. Check steering gear for clearance. Test and inspect brake system.

Perform steering sweep to ensure front brake hoses have adequate slack and do not contact any rotating, mobile or heated members. Inspect rear brake hoses at full extension for adequate slack. Failure to perform hose check/ replacement may result in component failure. Longer replacement hoses, if needed can be purchased from a local parts supplier.

Perform head light check and adjustment.

Re-torque all fasteners after 500 miles. Always inspect fasteners and components during routine servicing.

# CONTENTS OF YOUR KIT

## 123605 Box Kit (6" indexing Ring Kit)

Part #	Qty	Description
03416	1	6" Transmission Cross member
03424	1	Transfer Case Skid Plate Relocation
A281	1	6" Indexing Ring Assembly
03413	1	6" Indexing Ring
ARP15AJ1	11	3/8" x 1.645" Stud
987	1	Bolt Pack
	11	10mm-1.50 x 30mm Flat Head Socket Cap Screw
	11	3/8"-24 Hex Nut
	11	3/8" SAE Washer
	2	3/8"-16 x 1" Bolt
	2	3/8" SAE Washer
	2	3/8"-16 Serrated Edge Flanged Nut
099002	2	8-3/8 x.18 Cable Tie Tree
342701	1	Loctite - 1ml (11094-00764)

## 123615 Box Kit (8" indexing Ring Kit)

Part #	Qty	Description
03477	1	8" Transmission Cross member
03479	1	Transfer Case Indexing Bracket
A296	1	8" Indexing Ring Assembly
03478	1	8" Indexing Ring
ARP15AJ1	11	3/8" x 1.645" Stud
B1225	1	Indexing Ring Bag Kit
03424	2	Transfer Case Skid Plate Relocation
987	1	Bolt Pack
	11	10mm-1.50 x 30mm Flat Head Socket Cap Screw
	11	3/8"-24 Hex Nut
	11	3/8" SAE Washer
	2	3/8"-16 x 1" Bolt
	2	3/8" SAE Washer
	2	3/8"-16 Serrated Edge Flanged Nut
099002	2	8-3/8 x.18 Cable Tie Tree
997	1	Bolt Pack
	2	1/2"-13 Prevailing torque nut - yellow zinc
	2	1/2" SAE Washer - yellow zinc
	2	3/8"-16 x 1" Bolt - Grade 5 - Clear Zinc
	2	3/8" SAE Washer - Clear Zinc
	2	3/8"-16 Serrated Edge Flanged Nut - Clear Zinc
342701	1	Loctite - 1ml (11094-00764)

## TROUBLESHOOTING INFORMATION FOR YOUR VEHICLE

1. This indexing ring is only compatible with 2017-2019 Diesel trucks, and 2020+ 10 speed transmission trucks. Please verify your truck's equipment before installing.
2. Indexing ring has not been designed to work on manual shift transfer case models. Modification to the shift cable mount will be required.



**TECH  
TIPS**

## INSTALLATION INSTRUCTIONS

### SPECIAL TOOLS

(2) 3/8" Universal Joint Socket Adapter  
3" and 6" extensions

### INSTALLATION INSTRUCTIONS

1. Remove the transfer case skid plate if equipped. Save hardware for later installation (Fig 1).

**FIGURE 1**



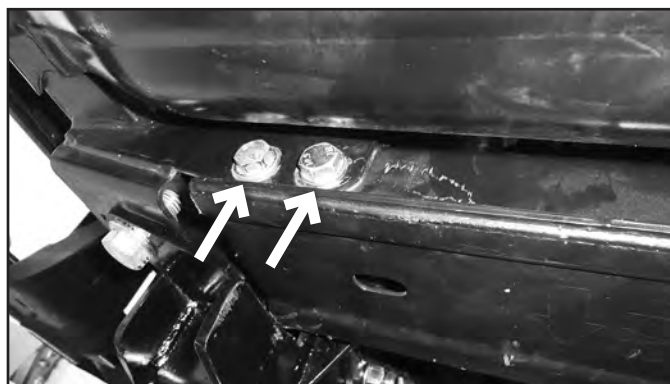
2. Mark orientation of the front drive shaft to the transfer case flange for later installation. Remove the four bolts attaching the front drive shaft to the transfer case. Save the hardware and using a strap, support the drive shaft from falling.
3. Mark orientation of the rear drive shaft to the rear axle flange for later installation. Remove the four bolts attaching the rear driveshaft to the rear axle. Save the hardware. Slide the rear driveshaft out from the transfer case and set aside for later installation.
4. Support the transmission with a hydraulic jack. It is best to use a piece of wood to prevent damage to the transmission oil pan.
5. Remove the two nuts attaching the transfer case isolator to the cross member (Fig 2).

**FIGURE 2**



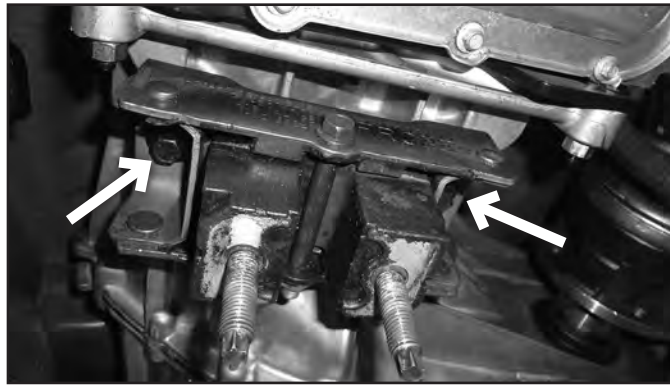
6. Remove the four 12mm bolts attaching the cross member to the frame. Lower the cross member from the frame. The factory cross member will not be used again (Fig 3). Save the bolts for later installation.

**FIGURE 3**



7. Remove the transfer case isolator from the transfer case (Fig 4). Save the isolator and hardware.

**FIGURE 4**



8. Disconnect the transfer case shift mechanism wiring harness, disconnect wiring harness clips from the transfer case (Fig 5).

**FIGURE 5**

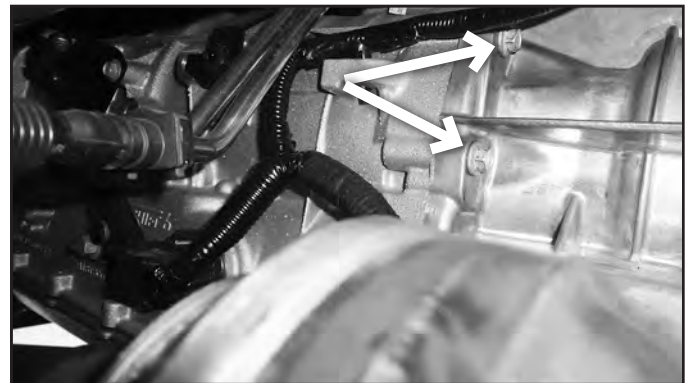


9. Disconnect the breather from the top of the transfer case.
10. Remove the 11 bolts attaching the transfer case to the transmission (Fig 6A & 6B). The hardware will not be reused. A combination of 3/8" universal joint socket adapters and 3/8" extensions works best to access all of the hardware.

**FIGURE 6A**



**FIGURE 6B**



11. With additional help, remove the transfer case from the vehicle by sliding it towards the rear of the vehicle. The transfer case may need to be rotated downwards to clear the body on the top side. Make sure the rear of the transfer case is supported so fluid does not spill out when set aside.
12. The transmission oil pan will need clearance for installation of the indexing ring at the driver side bolt. This can be done by either grinding the flange on the oil pan or flattening it with a hammer (Fig 7A & 7B). Test fit the indexing ring on to the transmission to ensure a flat fit and there is no gap between the transmission and indexing ring.

**FIGURE 7A**

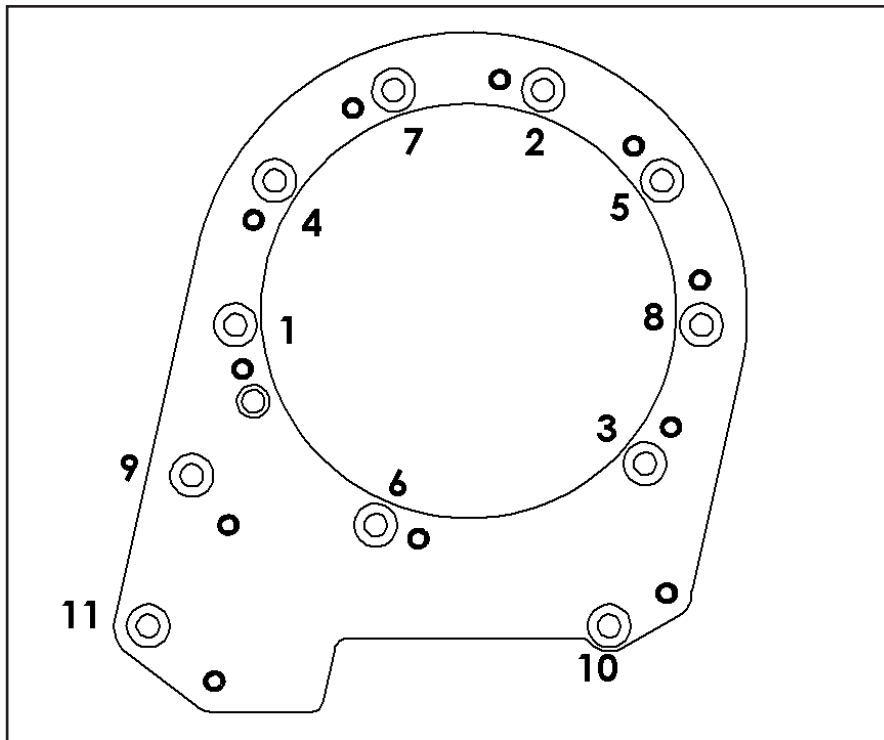


**FIGURE 7B**



13. Apply thread locker and loosely attach the indexing ring to the transmission with the provided flat head Allen bolts.  
*Note: The indexing ring has a specific orientation, it will only go on one way, rotate until all of the holes align.*
14. Tighten the indexing ring in the sequence below to 35ft-lbs.

**FIGURE 8**



15. Remove the hook on the transfer case (Fig 9). This will not be reinstated.

**FIGURE 9**



16. 2020+ Models only: Remove the alignment pin from the transfer case. It is indexed differently than 2017-2019 models and will interfere with a stud position on the indexing ring. It is easiest to cut the alignment pin flush with the case being careful to not cut into the transfer case.
17. Apply thread locker to all of the studs on the indexing ring.
18. Reinstall the transfer case to the transmission, ensuring the output shaft aligns with the transfer case and all of the studs on the indexing ring line up with the transfer case.
19. Using the provided 3/8" washers and nuts, tighten the transfer case to the studs on the indexing ring (Fig 10A & B). Torque to 45 ft-lbs. Follow the same tightening sequence as before.

*Hint: The transfer case can be lowered a little to help aid in tightening the nuts on the top side of the transfer case.*

**FIGURE 10A**

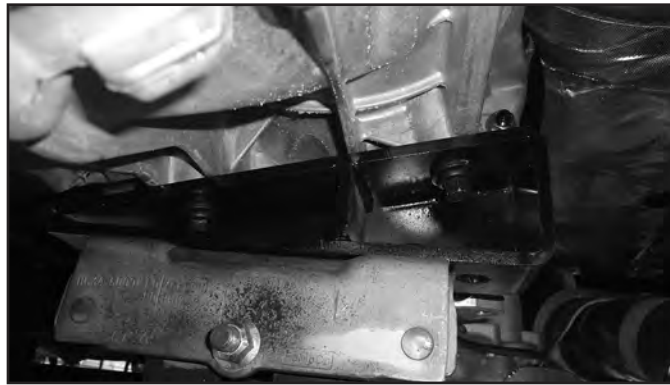


**FIGURE 10B**



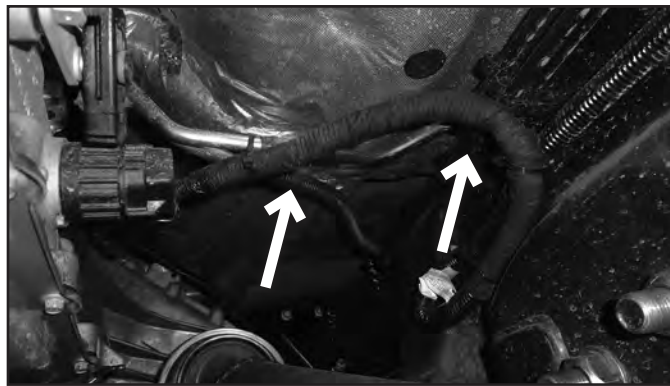
20. (123605 - 6" Kit only) Reinstall the transfer case isolator with the factory hardware and thread locker.
21. (123615 - 8" Kit only) Install the transfer case indexing bracket (03479) to the transfer case with the factory hardware and thread locker Figure 11. There is a clearance hole in the bottom of the bracket to allow a 3/8" extension through with the socket on the factory bolt on the inside of the bracket. Attach the transfer case isolator to the transfer case indexing bracket with the 1/2" nuts and washers in Bolt Pack 997 to the studs on the transfer case indexing bracket.

**FIGURE 11**



22. Route the wire harness above the front drive shaft. Attach wiring harness using the provided cable ties as shown in Figure 12. Plug the wire harness back into the transfer case

**FIGURE 12**



23. Reattach the transfer case breather into the transfer case.
24. Reinstall the front and rear drive shafts with the factory hardware and thread locker. Line up the marks for orientation of the drive shafts. Tighten to factory specifications.  
*Note: If the indexing ring is being installed in conjunction with a suspension lift kit, do not install the front drive shaft at this time.*
25. Install the new cross member with the factory 12mm hardware through the flanges on the frame. Tighten the factory 12mm hardware to 50 ft-lbs.. The cutout in the cross member will be on the driver's side to provide clearance to the front drive shaft (Fig 13).  
*Note: If the indexing ring is being installed with a 4-link suspension kit, do not tighten the factory 12mm hardware at this time.*

**FIGURE 13**



26. Lower the transmission / transfer case so that the isolator is resting on the new cross member. Remove the hydraulic jack / support from the transmission.
27. Attach the isolator to the cross member with the factory nuts (Fig 14). Tighten to factory specifications.

**FIGURE 14**



28. (123605 - 6" Kit only) Reattach the transfer case skid plate on the passenger's side with the factory hardware.

*Note: If the indexing ring is being installed with a 4-link suspension kit, do not install the transfer case skid plate at this time.*

29. (123605 - 6" Kit only) Attach the transfer case skid plate relocation bracket to the driver's side with the factory hardware. Position the bracket such that it is offset towards the rear of the vehicle. Use the provided 3/8" bolt, washer, and flange lock nut to attach the transfer case skid plate to the relocation bracket (Figure 14).

30. (123615 - 8" Kit only) Attach the transfer case skid plate relocation bracket to the driver's and passenger's sides with the factory hardware. Position the bracket such that it is offset towards the rear of the vehicle. Use the provided 3/8" bolt, washer, and flange lock nut (Bolt Packs 997 & 987) to attach the transfer case skid plate to the relocation bracket (Fig 15).

*Note: If the indexing ring is being installed with a 4-link suspension kit, do not install the transfer case skid plate at this time.*

**FIGURE 15**



**WE WANT TO SEE YOUR RIDE!**

Grab photos of your BDS-equipped truck in action and send them in for a chance to be featured. Send it in to our Bad Ass Rides customer gallery at [bds-suspension.com/bar](http://bds-suspension.com/bar) and post them on the BDS Fan Page on Facebook at [facebook.com/BDSSuspensions](https://facebook.com/BDSSuspensions). Don't forget about your BDS swag! BDS offers t-shirts, hoodies, decals and more available on the BDS website or through your local BDS distributor.

---

**TIME TO HAVE SOME FUN**

**Thank you for choosing BDS Suspension.**

For questions, technical support and warranty issues relating to this BDS Suspension product, please contact your distributor/installer before contacting BDS Suspension directly.