

INSTALLATION GUIDE

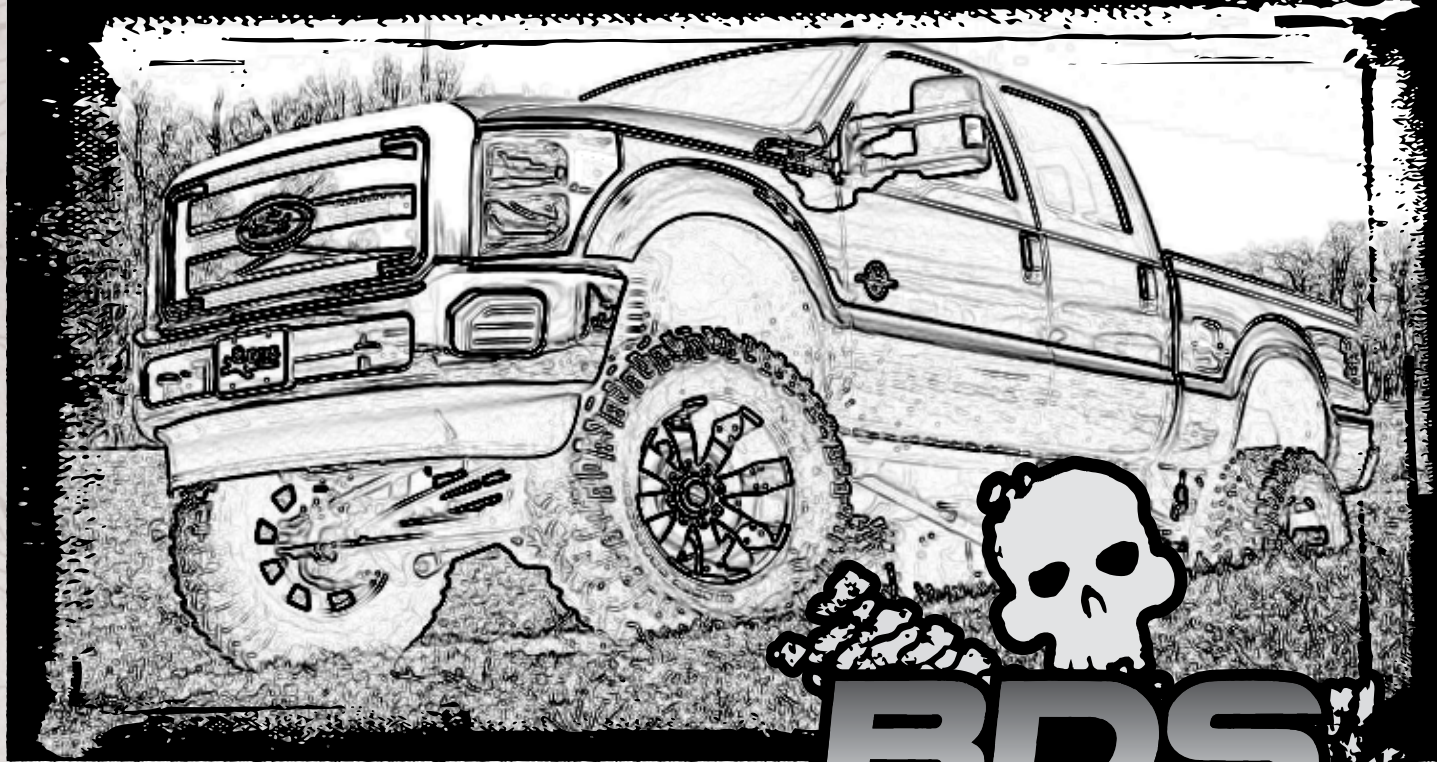

Part#: 013013, 013014

HARDCORE LIMITED LIFETIME WARRANTY

4" & 6" 4-Link Suspension Systems

Ford Super Duty 4WD | 2011-2016

Rev. 010820

491 W. Garfield Ave., Coldwater, MI 49036 • Phone: 517-279-2135
E-mail: tech-bds@ridefox.com

Read And Understand All Instructions And Warnings Prior To Installation Of System And Operation Of Vehicle.

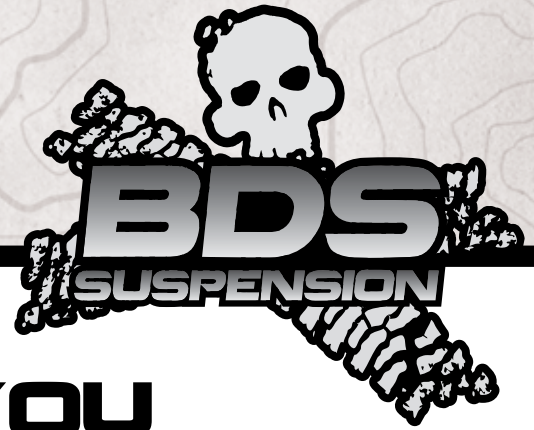

THANK YOU

Your truck is about to be fitted with the best suspension system on the market today. That means you will be driving the baddest looking truck in the neighborhood, and you'll have the warranty to ensure that it stays that way for years to come. Thank you for choosing BDS Suspension!

BEFORE YOU START

BDS Suspension Co. recommends this system be installed by a professional technician. In addition to these instructions, professional knowledge of disassembly/ reassembly procedures and post installation checks must be known.

FOR YOUR SAFETY

Certain BDS Suspension products are intended to improve off-road performance. Modifying your vehicle for off-road use may result in the vehicle handling differently than a factory equipped vehicle. Extreme care must be used to prevent loss of control or vehicle rollover. Failure to drive your modified vehicle safely may result in serious injury or death. BDS Suspension Co. does not recommend the combined use of suspension lifts, body lifts, or other lifting devices. You should never operate your modified vehicle under the influence of alcohol or drugs. Always drive your modified vehicle at reduced speeds to ensure your ability to control your vehicle under all driving conditions. Always wear your seat belt.

BEFORE INSTALLATION

- Special literature required: OE Service Manual for model/year of vehicle. Refer to manual for proper disassembly/reassembly procedures of OE and related components.
- Adhere to recommendations when replacement fasteners, retainers and keepers are called out in the OE manual.
- Larger rim and tire combinations may increase leverage on suspension, steering, and related components. When selecting combinations larger than OE, consider the additional stress you could be inducing on the OE and related components.
- Post suspension system vehicles may experience drive line vibrations. Angles may require tuning, slider on shaft may require replacement, shafts may need to be lengthened or trued, and U-joints may need to be replaced.
- Secure and properly block vehicle prior to installation of BDS Suspension components. Always wear safety glasses when using power tools.
- If installation is to be performed without a hoist, BDS Suspension Co. recommends rear alterations first.
- Due to payload options and initial ride height variances, the amount of lift is a base figure. Final ride height dimensions may vary in accordance to original vehicle attitude. Always measure the attitude prior to beginning installation.



Visit 560plus.com for more information.

TIRES AND WHEELS

35x12.50 x 17 w/ 4-1/2" -5" Backspace 4" kit

37x12.50 x 17 w/ 4-1/2" -5" Backspace 6" kit



BEFORE YOU DRIVE

Check all fasteners for proper torque. Check to ensure for adequate clearance between all rotating, mobile, fixed, and heated members. Verify clearance between exhaust and brake lines, fuel lines, fuel tank, floor boards and wiring harness. Check steering gear for clearance. Test and inspect brake system.

Perform steering sweep to ensure front brake hoses have adequate slack and do not contact any rotating, mobile or heated members. Inspect rear brake hoses at full extension for adequate slack. Failure to perform hose check/ replacement may result in component failure. Longer replacement hoses, if needed can be purchased from a local parts supplier.

Perform head light check and adjustment.

Re-torque all fasteners after 500 miles. Always inspect fasteners and components during routine servicing.

CONTENTS OF YOUR KIT

Box Kit		
Part #	Qty	Description
02026	1	4 Link Frame Bracket - Drv
02027	1	4 Link Frame Bracket - Pass
02024	2	Upper 4 Link Arm
02023	2	Lower 4 Link Arm
3527RB	8	4 Link Bushing
7	4	1.00 x 0.120 x 3.25 Arm Sleeve
60107	4	90 Deg Grease Fitting
432	1	Bolt Pack - 4 Link Brackets
	14	1/2"-13 x 1-1/2" bolt
	1	1/2"-13 x 1" bolt
	14	1/2"-13 prevailing torque nut
	28	1/2" SAE flat washer
	4	3/4"-10 x 5" bolt
	4	3/4"-10 prevailing torque nut
	8	3/4" SAE flat washer
	2	wire clip
	2	1/4"-20 x 3/4" bolt
	2	1/4"-20 prevailing torque nut
	4	1/4" SAE flat washer
02033	1	Track Bar Bracket
02418	1	Track Bar Bracket Spacer
02019	2	Cam Washer
01253	1	Sway Bar Drop Bracket (drv - 4" Lift)
01254	1	Sway Bar Drop Bracket (pass - 4" Lift)
01044	1	Sway Bar Drop Bracket (drv - 6" Lift)
01045	1	Sway Bar Drop Bracket (pass - 6" Lift)

Box Kit		
422	1	Bolt Pack
	4	3/8"-16 x 1-1/4" bolt
	4	3/8"-16 prev. torque nut
	8	3/8" USS flat washer
01001	2	Bump Stop Spacer
02416	1	Front Brakeline Bracket (Drv - 6" Lift)
02417	1	Front Brakeline Bracket (Pass - 6" Lift)
B130G5	2	8mm-1.25 x 130mm bolt
W56SAE	2	5/16" SAE Flat Washer
01555	1	Steering Stabilizer Bracket
YJTC5	1	Steel Stabilizer Spacer
657	1	Bolt Pack - Stabilizer
	2	1/2"-13 x 1-1/4" bolt
	2	1/2"-13 prevailing torque nut
	6	1/2" SAE flat washer
	1	12mm-1.75 x 80mm bolt
	1	12mm-1.75 prevailing torque nut
083404R	1	Pitman Arm
099000	2	Zip Tie
099002	2	Mountable Zip Tie

TROUBLESHOOTING INFORMATION FOR YOUR VEHICLE

1. Trackbar hardware at the frame requires 405 ft-lbs of torque, plan ahead on how to achieve this.
2. Pay attention to the notes about disconnecting the modules on the side of the frame rails, damage from vibration when installing 4-link brackets can occur.
3. BDS leaf springs are not intended for use beyond the truck's maximum payload capacity. Trucks equipped with overload springs will only have the capacity of a non-overload equipped truck. If heavy payload use is desired, supplemental rear air bags are recommended.

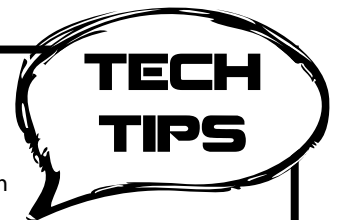

INSTALLATION INSTRUCTIONS

INSTALLATION INSTRUCTIONS

PRE INSTALLATION NOTE:

Unplug and remove the modules on the side of the frame rail to avoid damage from vibrations.

SPECIAL TOOLS

Pitman arm puller, cutoff tools, and general hand tools



FRONT INSTALLATION

1. Park the vehicle on a clean, flat surface and block the rear wheels for safety.
2. Disconnect the front track bar from the frame mount. Retain hardware.
3. Raise the front of the vehicle and support under the frame rails with jack stands.



Tip

As a result of the location of the long radius arm suspension, support locations are limited. Use your best judgment while supporting the vehicle with sufficient strength stands at appropriate locations. The radius arms will need to move freely during this installation.

4. Remove the front wheels.
5. Support the front axle with a hydraulic jack.
6. Disconnect the front brake line brackets from the axle (Fig 1). Retain hardware.

FIG. 1



7. Remove the clips holding the front brake lines to the brackets on the frame. (Fig 2A) Using a proper line wrench, break loose the hard line at the junction block and rotate it 180 degrees. (Fig 2B) This will put the rubber line to the bottom. Tighten the hard line securely. Leave the brake line loose and save the retaining clip.

FIG. 2A



FIG. 2B



8. Free the hub vacuum lines from the axle (Fig 3, 4).

FIG. 3



FIG. 4



9. Disconnect the sway bar end links from the sway bar. Retain hardware.
10. Remove the ABS line from the retaining tab on the radius arm (Fig 5A). Carefully pull the plastic retaining clip free from the radius arm (Fig 5B).

FIG. 5A

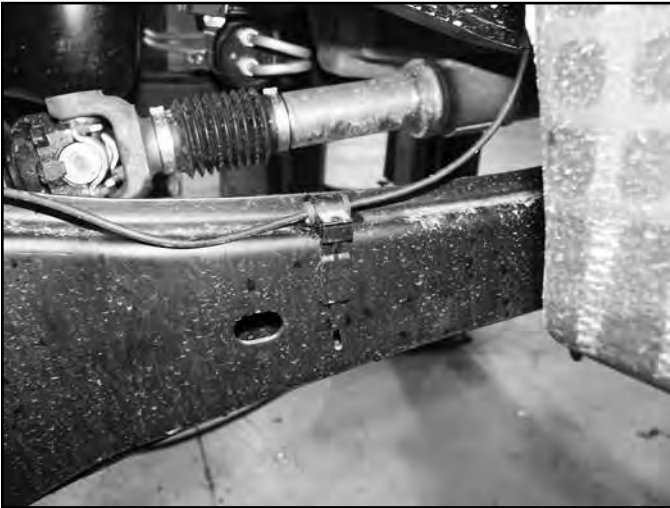
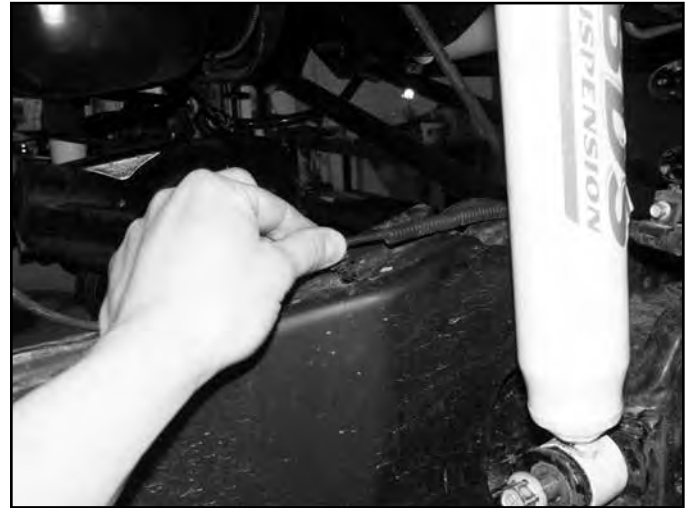
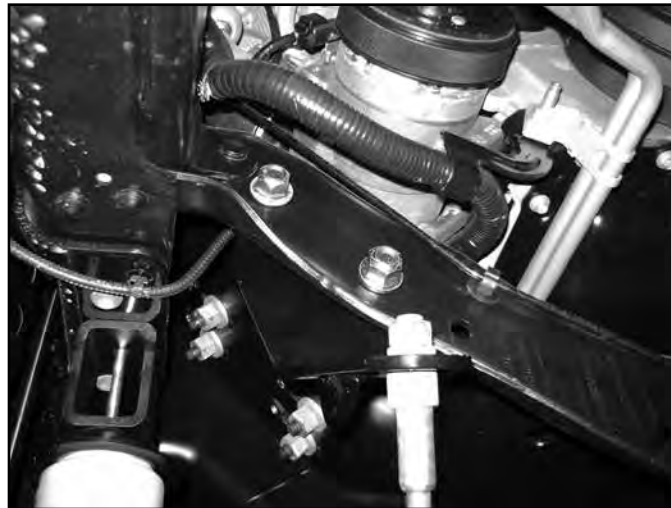

FIG. 5B



11. Disconnect the OE steering stabilizer from the frame mount.
12. Install the new steering stabilizer bracket (01555) to the passenger's side of the engine crossmember using existing holes and new 1/2" x 1-1/4" bolts, nuts and washers (BP 657) (Fig 6). Mount the stabilizer bracket to the back side of the crossmember. Torque hardware to 55 ft-lbs.

FIG. 6



13. Position the stabilizer under the new bracket and install with the provided 12mm hardware (BP 657) and 3/4" steel spacer (YJTC5). (Fig 7) Torque to 50 ft-lbs.

FIG 7



14. Disconnect the (5) bolts mounting the OE track bar bracket to the frame. Remove bracket and retain hardware.
15. Disconnect the drag link from the pitman arm. Retain hardware. Free the drag link from the pitman arm with a pickle fork.
16. Remove the pitman arm nut. Note the indexing of the pitman arm in relation to the steering sector shaft and remove the pitman arm from the steering box using the appropriate puller.
17. Remove all of the dri-lock compound on the threads of the OE nut and steering sector shafts. This is important to ensure that the new thread lock compound will adhere properly.
18. Apply a bead of the supplied thread lock all the way around the threads of the OE nut.
19. Install the new pitman arm (indexed the same as the OE) and fasten with the OE nut. Torque the nut to 350 ft-lbs.
20. Remove the OE shocks. Retain lower mounting hardware.
21. Lower the axle until the OE coil springs are free and remove the springs from the vehicle. Retain the upper spring isolator for use with the new springs.

! Caution *Do not over extend the brake lines.*

22. Install the new track bar bracket (02033) using the stock mounting hardware as it was removed (Fig 8A,B). Place the provided 3-hole spacer plate (02418) between the new bracket and the frame crossmember. Torque all (5) mounting bolts to 129 ft-lbs.

FIG. 8A (FROM FRONT)



FIG. 8B (FROM REAR)



23. Pull the OE front bump stops free from the bump stop cups and remove the bolt mounting the cup to the frame (Fig 9).

FIG. 9



24. Position the cup on the provided bump stop extension. (01001) The alignment tab on the bump stop cup will fit in the second hole in the extension.
25. Install a provided 8mm x 130mm bolt and 5/16" SAE washer through the cup extension and attach to the frame in the original hole. Use Loctite on the threads and torque to 20 ft-lbs (Fig 10).

FIG. 10



26. Loosen the four radius arm-to-axle mounting bolts but do not remove. Once again, ensure that the front axle is well supported.
27. Starting with the passenger's side, remove the upper radius arm-to-axle mounting bolt. Remove the radius arm-to-frame bolt as well. This will allow the radius arm to swing down away from the frame. Remove the lower radius arm-to-axle bolt and remove the arm from the vehicle. Retain hardware.
28. Lightly grease and install the provided bushings (3527RB) and sleeves (7-1) in the four new control arms (02023, 02024).
29. Install the provided 90° grease fittings in the threaded holes at the bushing end of the control arms. When installed the fittings should point toward the body of the control arm. (Fig. 11)

FIG. 11



30. Locate the seven rivets that attach the OE radius arm mounting bracket to the frame. There will be four on the outside and three in the inside of the bracket fastening the bracket to the bottom of the frame. (Fig. 12)

FIG. 12



31. Remove the seven rivets with a grinder, or drill, or combination of these tools. Do not use a torch or air chisel. The undercoating used on the frame is highly flammable. Also, an electronic control module and fuel lines are mounted and ran on the inside of the driver's side frame rail.
32. With the rivets removed, free the radius arm bracket from the frame. Ensure that all of the rivets are removed from the holes in the frame.
33. Place the new passenger's side 4-Link bracket (02027) up to the frame and align the existing rivet holes with the corresponding holes in the bracket. Attach the bracket with $\frac{1}{2}$ " x 1-1/2" bolts, nuts and $\frac{1}{2}$ " SAE flat washers from bolt pack #432. Torque $\frac{1}{2}$ " hardware to 90 ft-lbs. (Fig. 13A, 13B)

FIG. 13A



FIG. 13B

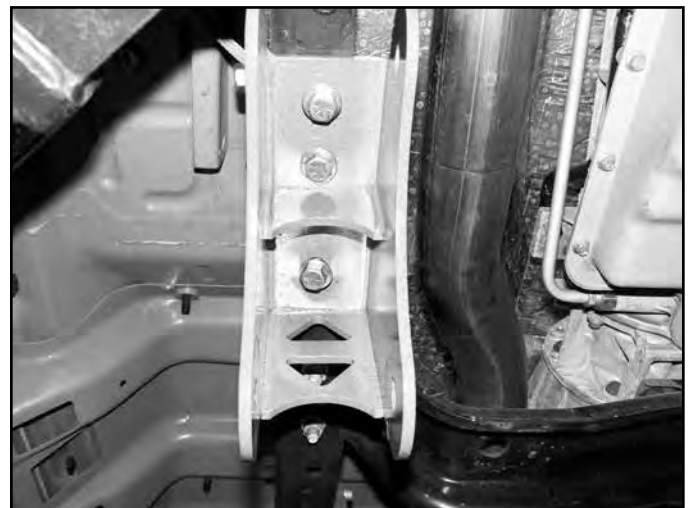

34. Install the assembled upper control arm in the new frame bracket and fasten with a $\frac{3}{4}$ " x 5-1/2" bolt, nut and $\frac{3}{4}$ " SAE flat washers from bolt pack #432. The two tabs on the control arm go up. Leave hardware loose. (Fig. 14)
35. Attach the axle end of the control arm with the original hardware. Leave hardware loose. (Fig. 15)

FIGURE 14



FIGURE 15

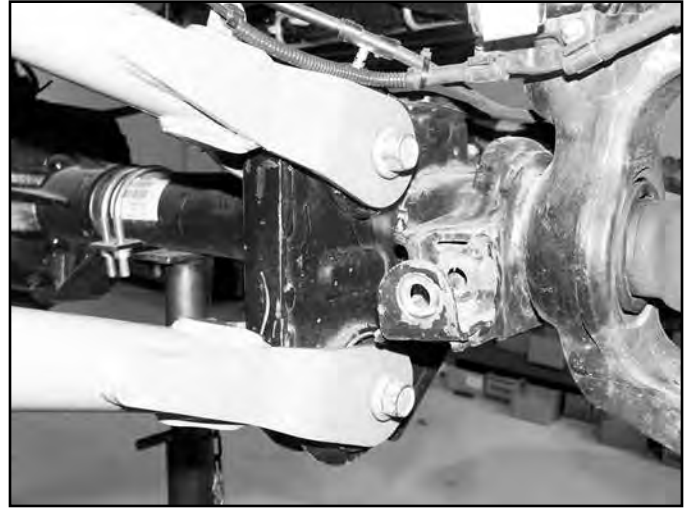

36. Install the new lower control arm in the new frame bracket with a $\frac{3}{4}$ " x 5-1/2" bolt, nut and $\frac{3}{4}$ " SAE flat washers. Install arm so that the grease fitting is up. Leave hardware loose.
37. With the axle well supported, disconnect the driver's side radius arm from the axle. Retain hardware.
38. Attach the new passenger's side lower control arm to the axle with the original hardware. Leave hardware loose.
39. If equipped, remove the 3 nuts mounting the fuel module to the inside of the driver's side frame rail above the radius arm bracket (Fig 16A). Remove the fuel lines from the clip just ahead of the fuel module on the inside of the frame and pull the module in, away from the frame (Fig 16B). Retain hardware.

FIG. 16A



FIG. 16B

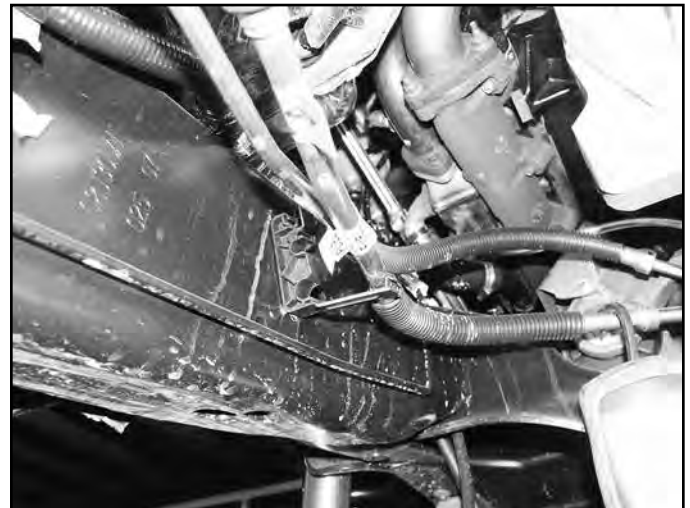

40. Repeat the frame bracket and control arm installation procedure on the driver's side of the vehicle. When mounting the new bracket, use a $\frac{1}{2}$ " x 1" bolt in the 2nd (from the front) outside mounting hole (Fig 17A). This shorter bolt is necessary to properly clear the fuel module when it is reinstalled. Note: Use the nut that was removed from the radius arm-to-frame bolt for the upper control arm-to-axle mount bolt when installing the new control arm. The OE nut in this position is welded to the radius arm.
41. Install the provided fuel module spacer plate over the 3 studs of the fuel module bracket and reinstall the module in the original holes with the factory nuts (Fig 17B). Torque nuts to 20 ft-lbs.

FIGURE 17A

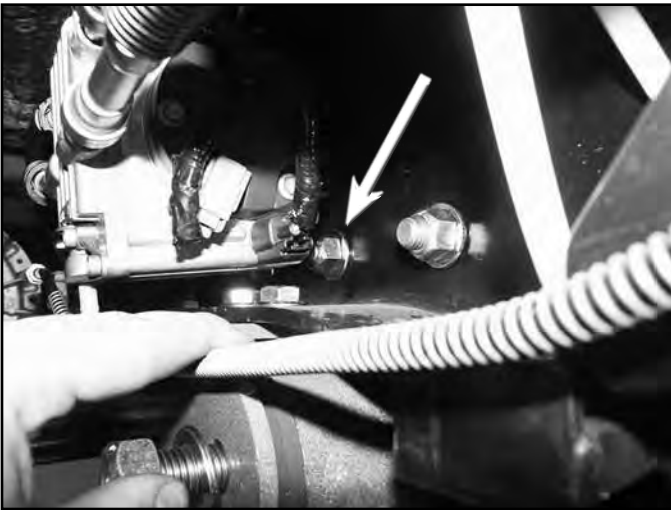
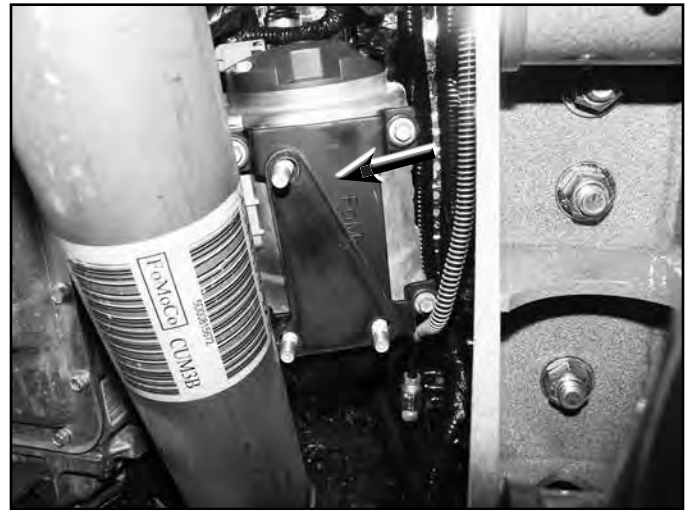
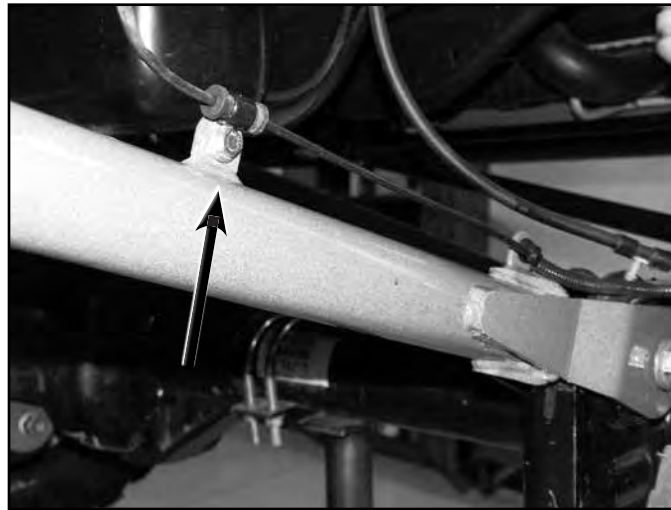

FIGURE 17B



42. With all of the control arms attached, reinstall the fuel junction block (if removed) on the driver's side frame rail. Torque hardware to 20 ft-lbs.
43. Attach the plastic ABS wire clip to the front tab on the new upper control arm. Secure the wire to the rear tab with the provided wire clip and 1/4" x 3/4" bolt, nut and 1/4" USS washers. Torque 1/4" hardware to 10 ft-lbs. (Fig. 18)

FIG. 18



44. Install the new coil springs in conjunction with the OE top isolator. Rotate the springs so that they seat in the bottom coil perch properly.
45. Install the new shocks using the original lower mounting hardware and the provided upper mounting hardware. Torque the lower bolt to 100 ft-lbs and the upper until the bushings begin to swell.
46. Note the orientation of the front sway bar (top versus bottom). Disconnect the sway bar from the frame and remove from the vehicle. Retain hardware.
47. Install the provided sway bar drop bracket to the original sway bar frame mounting locations with the original hardware. Mount the drop bracket with the open face toward the inside of the vehicle and the bracket offset toward the front. Torque hardware to 30 ft-lbs.
48. Attach the sway bar to the new drop brackets in the correct orientation with the 3/8" hardware from bolt pack #422. Torque hardware to 30 ft-lbs (Fig 19).

FIG. 19

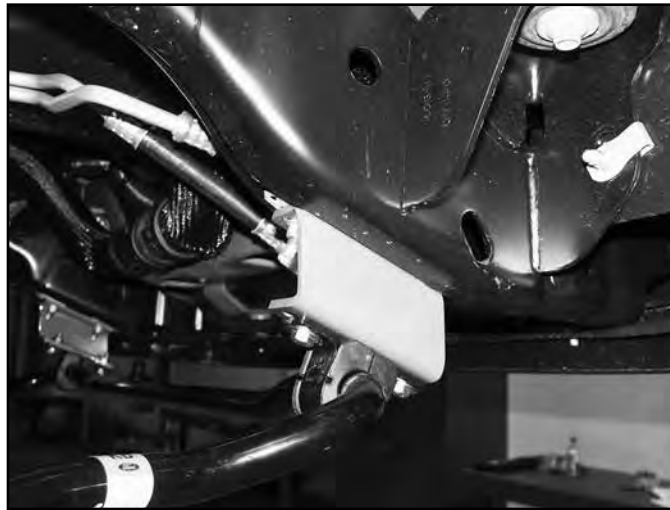

49. Install the sway bar link ends to the sway bar and secure with the OE hardware. Torque to 90 ft-lbs.
50. The ABS lines need to be rerouted along the frame. Make a mark on the frame approximate 1-1/2" behind the coil bucket and 1-1/2" from the bottom of the frame. Drill a 7/32" hole at the mark. Drill a second 7/32" hole in the inner fender liner, straight back from the first hole location. (Fig 20A)

FIG. 20A



51. Locate the provided wire clamps, 1/4" self tapping bolts (BP 656) and mountable zip ties (tree on the end). With the suspension at full extension (hanging from shocks) ensure that the ABS line still has some slack from the new mounting point on the frame to the axle. Fasten the line to the frame with the wire clamp and 1/4" self-tapping bolt. (Fig 20B) Attach the loose end inside the inner fender with the mountable zip tie.



Tip

The rubber collar on the ABS line can be slid on the line using a little silicone spray.

FIG 20B



52. 4" Lift Only: Remove the factory front brake line brackets from the frame. The brackets have a squared edge in the brake line mounting hole. (Fig 21A) Using a file or rotary grinder, remove the square edge to form a complete round hole. (Fig 21B) Reattach the brackets to the frame tighten securely with the factory hardware. Install the brake line junction in the bracket from the bottom and fasten with the factory retaining clip. (Fig 21C)

FIG 21A

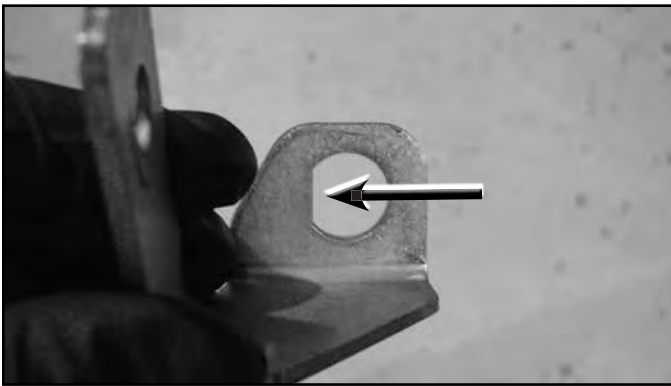

FIG 21B



FIG 21C



53. 6" Lift Only: Remove the factory brake line brackets from the frame. Install the new provided brake line brackets and secure with the factory hardware. Carefully reform the brake hard line and install the junction block through the bottom of the new bracket. (Fig 22) Fasten with the original brake line clip.

FIG. 22



54. Properly bleed the brake system of air and top off the brake fluid reservoir with the proper type of fluid (see owners manual).
55. Install the wheels and lower the vehicle to the ground.
56. Attach the track bar to the new bracket with the OE hardware. Turn the steering wheels to aid in aligning the track bar in the bracket. Install the provided cam washers between the alignment tabs on the bracket. Position the cam washers so that the hole is closer to the driver's side (Fig 23) for 4" kits. The hole should be closer to the passenger's side for 6" kits. Torque hardware to 406 ft-lbs.
57. Torque all six radius arm bolts to 250 ft-lbs.

FIG. 23



REAR INSTALLATION

58. Raise the rear of the vehicle and support with jack stands under the frame rails just ahead of the spring hangers.
59. Remove the wheels.
60. Support the axle with a hydraulic jack.
61. Remove the OE shocks. Retain all mounting hardware.
62. Remove the ABS wires from the axle bracket. Remove brakeline retaining clips holding brakeline hardlines in place. Pull the brakelines through the mounting bracket and trim a slot to remove them from the bracket. Use extra caution to not damage the brakelines. (Fig 24).

FIG. 24



BLOCK KIT ONLY (4" KIT)

63. Disconnect the passenger's side spring u-bolts. Using two C-Clamps, clamp the leaf spring on each side of the top u-bolt plate. (Fig 25) Remove the center pin nut and remove the u-bolt plate. Reinstall the center pin nut and torque to 40 ft-lbs. The u-bolts, top plate and bottom plate will not be reused.

FIG 25



64. Remove the factory lift block. It will not be reused.
65. Lower the axle enough to place the provided 5" lift block between the axle and the leaf spring. Position the block so the bump stop wing faces inward. Make note that there are two center pin holes in the new blocks. The center pin will need to be aligned to the rear hole. This will ensure the axle moves slightly forward and the wheels are aligned properly in the wheel well.
66. Raise the axle to engage the block spring alignment pins. Be certain the leaf center pin aligns with the REAR hole in the new lift block. Position the new u-bolt plate on the top of the spring over the center pin nut. Position the plate so the bolt pattern is shifted forward on the spring. (Fig 26) Fasten the entire assembly with the provided u-bolts and flanged nuts. Snug but do not torque the u-bolts at this time.

FIG 26



67. Repeat block installation of the driver's side. Take care not to over extend the brake lines.



Tip

The parking brake cable bracket will need to be removed from the spring center pin. (Fig 26)

LEAF SPRING KIT ONLY

68. Disconnect the passenger's side u-bolts and lower the axle from the spring.
4" Kit: Remove the OE block, it will not be reused.
6" Kit: Retain OE block to be installed with new spring.
69. Loosen and remove the front spring-to-frame and rear shackle-to-frame bolts and remove the spring from the vehicle.
70. Remove the shackle from the OE spring and loosely install it on the new rear spring. Be sure that the shackle is oriented on the new spring identical to the old. The shackles mount of the longer end of the spring (opposite of the end marked with "FRT").
71. Install the new spring in the vehicle with the OE bolts. Leave hardware loose. All of the spring pivot bolts will be torqued with the weight of the vehicle on the springs.
72. Remove all dirt and corrosion from the axle spring pad and raise the axle to the spring while aligning the center pin with the center pin hole. Fasten the spring with the provided u-bolts and new top u-bolt plate. Position the u-bolt plate so the bolt pattern is centered on the center pin.. Snug but do not torque u-bolts at this time.
73. Repeat the procedure on the driver's side. Disconnect the parking brake cable bracket from the center pin (Fig 27). Take care not to over extend the brake lines.

FIG. 27



74. If more parking brake cable slack is needed, remove the cable from the rear-most retaining bracket on the frame. (Fig 28)

FIG. 28

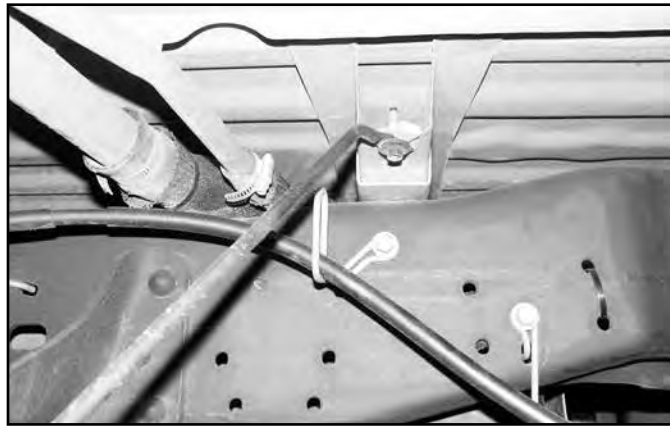

BLOCK AND LEAF SPRINGS KITS

75. Install the new shocks with the original mounting hardware.
76. Install new brakeline relocation bracket on the axle with stock breather tube stud. Install brakelines with original clips into the new bracket. Attach ABS wires into the new bracket. Attach diff breather line to the axle breather stud. (Fig 29).

FIG. 29

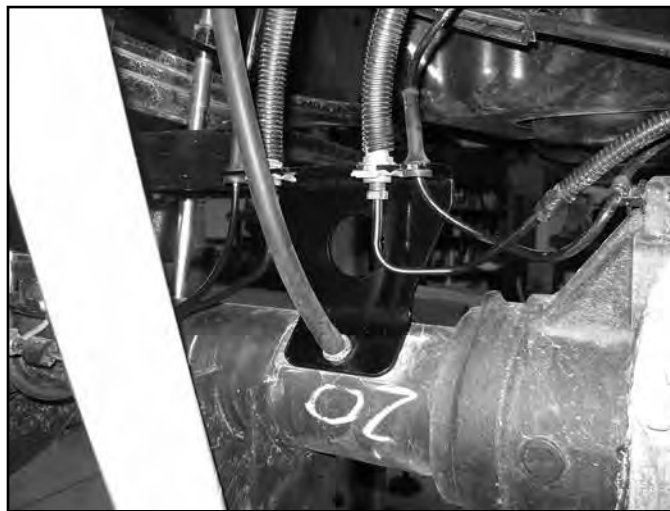

77. Install wheels and lower the vehicle to the ground.
78. With the weight of the vehicle on the axle, torque the u-bolts to 130-150 ft-lbs.
79. Check all hardware for proper torque.
80. Adjust steering wheel.
81. Adjust headlights
82. Check hardware after 500 miles.

TIME TO HAVE SOME FUN

Thank you for choosing BDS Suspension.

For questions, technical support and warranty issues relating to this BDS Suspension product, please contact your distributor/installer before contacting BDS Suspension directly.



WE WANT TO SEE YOUR RIDE!

Grab photos of your BDS-equipped truck in action and send them in for a chance to be featured. Send it in to our Bad Ass Rides customer gallery at bds-suspension.com/bar and post them on the BDS Fan Page on Facebook at facebook.com/BDSSuspensions. Don't forget about your BDS swag! BDS offers t-shirts, hoodies, decals and more available on the BDS website or through your local BDS distributor.

INSTALLATION GUIDE

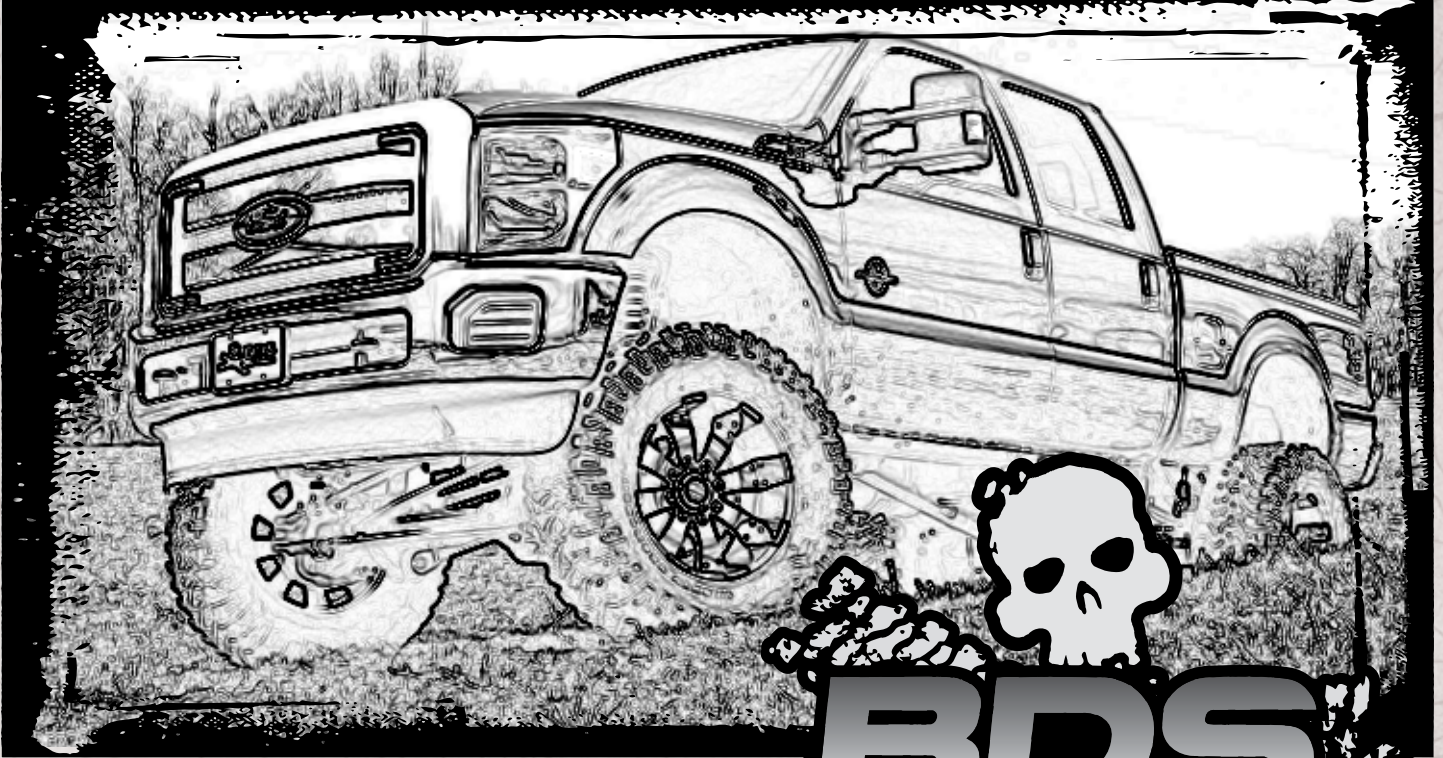

Part#: 123612



HARDCORE LIMITED LIFETIME WARRANTY

Superduty Coilover Conversion

Ford F-150/ F-350 Superduty 4WD | 2005-2016

Rev. 011018

491 W. Garfield Ave., Coldwater, MI 49036 • Phone: 517-279-2135

Web: www.bds-suspension.com • E-mail: tech-bds@sporttruckusainc.com

Read And Understand All Instructions And Warnings Prior To Installation Of System And Operation Of Vehicle.

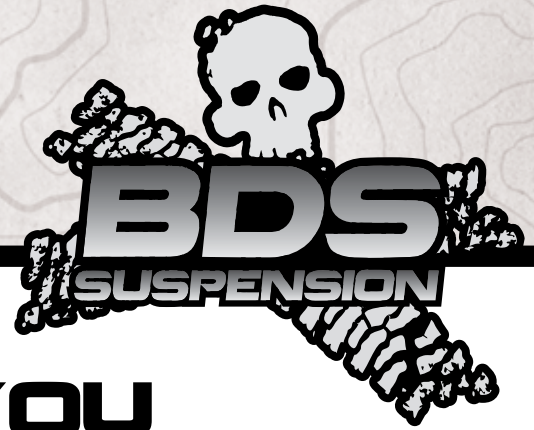

THANK YOU

Your truck is about to be fitted with the best suspension system on the market today. That means you will be driving the baddest looking truck in the neighborhood, and you'll have the warranty to ensure that it stays that way for years to come.

Thank you for choosing BDS Suspension!

BEFORE YOU START

BDS Suspension Co. recommends this system be installed by a professional technician. In addition to these instructions, professional knowledge of disassembly/ reassembly procedures and post installation checks must be known.

FOR YOUR SAFETY

Certain BDS Suspension products are intended to improve off-road performance. Modifying your vehicle for off-road use may result in the vehicle handling differently than a factory equipped vehicle. Extreme care must be used to prevent loss of control or vehicle rollover. Failure to drive your modified vehicle safely may result in serious injury or death. BDS Suspension Co. does not recommend the combined use of suspension lifts, body lifts, or other lifting devices. You should never operate your modified vehicle under the influence of alcohol or drugs. Always drive your modified vehicle at reduced speeds to ensure your ability to control your vehicle under all driving conditions. Always wear your seat belt.

BEFORE INSTALLATION

- Special literature required: OE Service Manual for model/year of vehicle. Refer to manual for proper disassembly/reassembly procedures of OE and related components.
- Adhere to recommendations when replacement fasteners, retainers and keepers are called out in the OE manual.
- Larger rim and tire combinations may increase leverage on suspension, steering, and related components. When selecting combinations larger than OE, consider the additional stress you could be inducing on the OE and related components.
- Post suspension system vehicles may experience drive line vibrations. Angles may require tuning, slider on shaft may require replacement, shafts may need to be lengthened or trued, and U-joints may need to be replaced.
- Secure and properly block vehicle prior to installation of BDS Suspension components. Always wear safety glasses when using power tools.
- If installation is to be performed without a hoist, BDS Suspension Co. recommends rear alterations first.
- Due to payload options and initial ride height variances, the amount of lift is a base figure. Final ride height dimensions may vary in accordance to original vehicle attitude. Always measure the attitude prior to beginning installation.



Visit 560plus.com for more information.

TIRES AND WHEELS

See Lift Kit Specifications



BEFORE YOU DRIVE

Check all fasteners for proper torque. Check to ensure for adequate clearance between all rotating, mobile, fixed, and heated members. Verify clearance between exhaust and brake lines, fuel lines, fuel tank, floor boards and wiring harness. Check steering gear for clearance. Test and inspect brake system.

Perform steering sweep to ensure front brake hoses have adequate slack and do not contact any rotating, mobile or heated members. Inspect rear brake hoses at full extension for adequate slack. Failure to perform hose check/ replacement may result in component failure. Longer replacement hoses, if needed can be purchased from a local parts supplier.

Perform head light check and adjustment.

Re-torque all fasteners after 500 miles. Always inspect fasteners and components during routine servicing.

CONTENTS OF YOUR KIT

Box Kit 123612

Part #	Qty	Description
02714	1	05+ Ford Superduty Coilover Conversion Upper Brkt - DRV
02715	1	05+ Ford Superduty Coilover Conversion Upper Brkt - PASS
02716	2	05+ Ford Superduty Coilover Conversion - lower bracket
02856	2	Upper Reservoir Mounting Bracket
952	1	Bolt Pack - Mounting Brackets
953	1	Bolt Pack - Lower Hardware
	1	loc-tite
54314	2	5/8" x 1/2" ID x 1.47" Sleeve
54587	2	3/4" x 9/16" x 1.575" Sleeve
SB33BK	2	5/8" ID bushing - Upper
SB35BK	2	3/4" ID bushing - Lower
02906	2	Bump Stop Spacer Plate

Bolt Pack # 952

Part #	Qty	Description
	2	1/2"-13 x 6" Bolt - Grade 8 - Yellow Zinc
	2	1/2"-13 x 5" Bolt - Grade 8 - Yellow Zinc
	2	1/2"-13 x 3" Bolt - Grade 8 - Yellow Zinc
	14	1/2"-13 x 1-1/2" Bolt - Grade 8 - Yellow Zinc
	4	1/2"-13 x 5/8" Bolt - Grade 5 - Clear Zinc
	18	1/2"-13 Prevailing Torque Nut
	38	1/2" SAE Thru-Hardened Washer - Yellow Zinc
	4	1/2" SAE Washer - Clear Zinc

Bolt Pack # 953

Part #	Qty	Description
	2	14mm-2.00 x 30mm Bolt - Class 10.9 - Clear Zinc
	2	14mm Flat Washer - Clear Zinc
	2	7/16" Clamp w/ 0.281 Hole (Fastenal # 0708762)
	4	1/4"-20 x 3/4" Bolt - Grade 5 - Clear Zinc
	4	1/4"-20 Nylock Nut - Clear Zinc
	8	1/4" SAE Washer - Clear Zinc
	4	#10-24 x 3/4" #2 Drive Pan Head Phillips Machine Screw - Clear Zinc
	4	#10-24 Serrated Edge Flanged Nut - Clear Zinc
	4	#10 SAE Washer - Clear Zinc

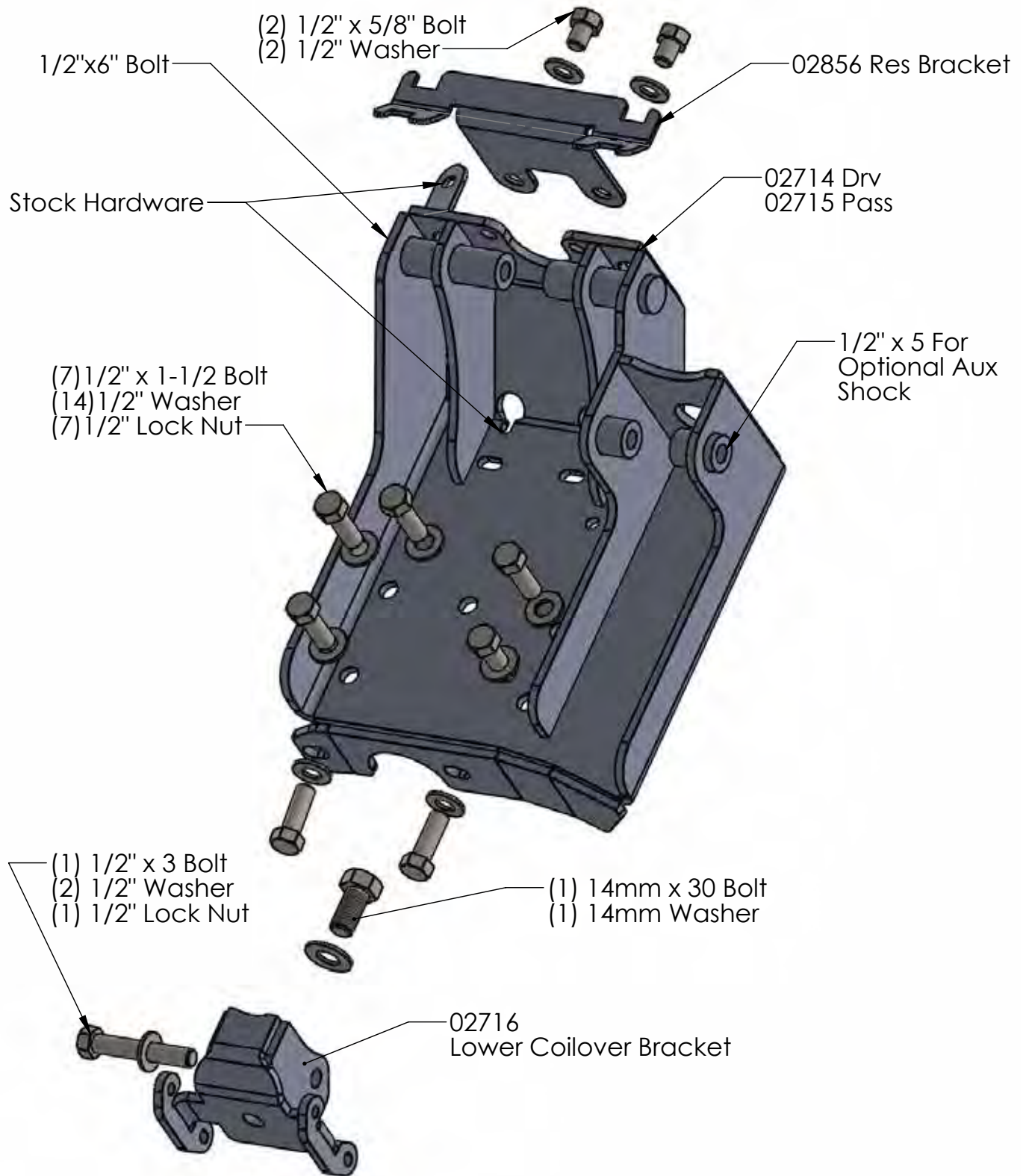

TROUBLESHOOTING INFORMATION FOR YOUR VEHICLE

1. Coilover mounting brackets are designed to replace the factory coil buckets and lower coil seat. Use care to not damage the frame or any electronic modules when performing the installation.

INSTALLATION INSTRUCTIONS

INSTALLATION INSTRUCTIONS

1. Park vehicle on clean, flat, and level surface. Block the rear wheels for safety.
2. Raise the front of the vehicle and support the frame rails with jackstands. Do not support the front of the vehicle on any suspension components.
3. Support the front axle with a hydraulic jack. Remove the front wheels.
4. Disconnect the modules on the side of the frame rail before beginning the installation. Vibration from an air hammer may damage the modules and are expensive to replace. Modules may not be present on earlier year / gas engine configuration trucks. Reattach at the end of the installation. (Fig 1a, 1b)

SPECIAL TOOLS

Drill, Grinder, & General Tools

FIG 1A



FIG 1B



5. Remove the front shocks from the vehicle, disconnect the ABS wire and brake line from the lower axle. (Fig 2)

FIG 2



6. Remove the coils from the vehicle.
7. Remove the factory lower coil perch, the hardware will not be reused.
8. Install the new lower bracket with 14mm hardware with loc-tite. Tighten bolt to 95 ft-lbs. (Fig 3)

FIG 3

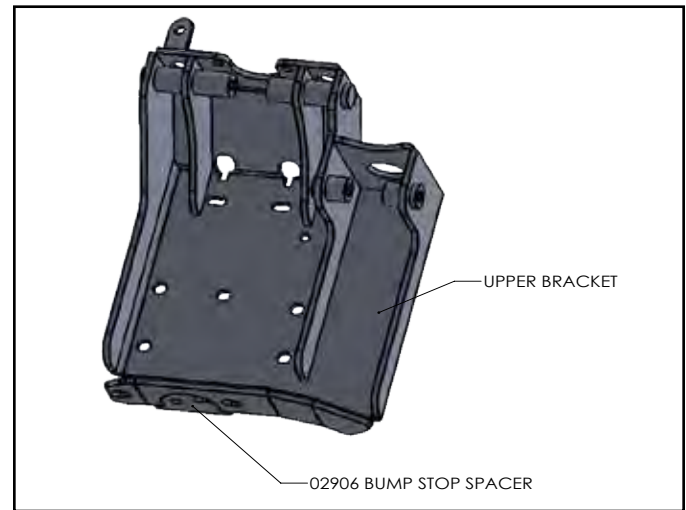

9. On the driver's side only, disconnect the ABS module above the coil bucket. Retain all of the hardware. Raise the module slightly so it is not contacting the coil bucket.
10. Remove the factory bump stops / bump stop brackets. Retain hardware.
11. Remove the 7 rivets that attach the coil bucket to the frame rails. Many methods can be used to remove the rivets. Remove the seven rivets with a grinder, or drill, or combination of these tools. Do not use a torch or air chisel. The undercoating used on the frame is highly flammable. Vibrations from air chisels may damage electronic modules.
12. Install the new coilover mounting bracket with $\frac{1}{2}$ " x 1-1/2" hardware (BP #952). Tighten to 65 ft-lbs. (Fig 4a, 4b) Install the bump stop spacer plate and install bumpstop brackets / bumpstops to the bottom side of the coilover bracket. These are included with the rest of the lift kit. Bump stops must be installed in conjunction with the kit.

FIG 4A**FIG 4B**

13. Reattach the ABS module with factory hardware to the driver's side coilover bracket.
14. Raise or lower the axle to attach the coilover to both brackets. Attach the upper mount with $\frac{1}{2}$ " x 6" bolt with loc-tite, and lower with $\frac{1}{2}$ " x 3" hardware. The reservoir hose will go out towards the front of the vehicle. Tighten the hardware to 65ft-lbs.
15. Attach the reservoir bracket to the coilover bracket with $\frac{1}{2}$ " x 5/8" hardware. Use loc-tite on threads.
16. Attach the reservoir to the bracket with the included hoseclamps.
17. If an auxiliary shock is going to be installed, use the included 1-1/2" wide upper mount bushing / sleeve combination with $\frac{1}{2}$ " x 5" hardware. Tighten to 65 ft-lbs. Attach the lower mount with factory hardware with wider bushing / sleeve setup.
18. Attach the ABS wire to the rear of the new lower coilover mount with #10 hardware (#953).
19. Attach the brake line bracket to the front side of the lower coilover mount. The stock brake line will use the factory bracket with $\frac{1}{4}$ " hardware (#953). Aftermarket brake lines may require part of the factory brake line bracket as shown. Attach with included clamp with $\frac{1}{4}$ " hardware, other variations may be required. Ensure there is adequate slack in the brake line at full droop and full steering sweep. Check again later in the installation at ride height, repeat full steering sweep. (Fig 5)

FIG 5

20. Reinstall wheels. Tighten lug nuts to factory specification. Lower vehicle to the ground.
21. Reattach modules to the side of the frame rails with factory hardware.
22. Recheck all hardware for proper torque. Recheck again after 500 miles.



WE WANT TO SEE YOUR RIDE!

Grab photos of your BDS-equipped truck in action and send them in for a chance to be featured. Send it in to our Bad Ass Rides customer gallery at bds-suspension.com/bar and post them on the BDS Fan Page on Facebook at facebook.com/BDSSuspensions. Don't forget about your BDS swag! BDS offers t-shirts, hoodies, decals and more available on the BDS website or through your local BDS distributor.

TIME TO HAVE SOME FUN

Thank you for choosing BDS Suspension.

For questions, technical support and warranty issues relating to this BDS Suspension product, please contact your distributor/installer before contacting BDS Suspension directly.