



**DOWNLOAD ENHANCED
INSTALL MANUALS AT
*dieselperformance.com***



**BD Remote Mount Vacuum Exhaust Brake
Installation Manual**

D o d g e / F o r d / C h e v r o l e t T r u c k s

Covering BD Part Numbers#: (Application Diagram inside manual)	1037133 / 1037135 / 1037136 / 1037115 / 1037141 / 1037142 / 1037143 / 1037144
---	--

Serial # _____

Date Purchased _____

Purchased from _____

Installed by _____

OWNER'S MANUAL – LEAVE IN GLOVE BOX
Installation Manual Part # I1037135

TABLE OF CONTENTS

Generic Vacuum Brake Parts	3
STANDARD REQUIRED PARTS – 40/60.....	3
Welcome.....	4
Application List.....	4
Options	4
Valve Assembly Installation	5
Control Valve Assembly	6
Throttle Switch Installation	7
Ford Pick-up 1983-94 (Non-PowerStroke).....	7
Ford PowerStrokes (1994-2000).....	8
DFIV Wiring Diagram.....	8
Chevrolet/GMC (1994-2000) 6.5L Trucks	9
Chevrolet/GMC (1982-93) 6.2/6.5L and Generic Applications	9
Dodge 1988-1993	9
Dodge 1994 to 1998 12V	9
Dodge 1998 to 2002 24V	10
Dodge 2001-2002 HO 6spd (ONLY)	10
Dodge DFIV Wiring Diagram (1998½ - 2002).....	11
On all throttle switch applications (except PowerStrokes):.....	11
DFIV Calibration	12
Power and Toggle Switch	12
Cruise Control Disable	13
Chevrolet/GMC Cruise Control Disable	13
Ford Powerstroke	13
Dodge Cruise Disable	14
2000 to 2002 (245HP HO 6 Speed) (Only):	14
Exhaust Brake Routing Diagram.....	15
Optional Manual Shifter (Push-Pull Style).....	16
Optional Brake Pressure Gauge	16
Testing.....	17
Vacuum Brake Troubleshooting Guide	18
Operating Guidelines	19

Generic Vacuum Brake Parts

STANDARD REQUIRED PARTS – 40/60				
	Description	Part Number	Qty	
1	Brake Valve	1137000 or 1137005	1	REQ'D
2	Spool Valve	1230001	1	REQ'D
3	Marmon Clamps	1100404	2	REQ'D
STEP #2 – THROTTLE SWITCH SELECTION				
4	DFIV module	1321039	1	○
5	Micro Switch	1300420	1	○
STEP #3 – EXHAUST PIPE SIZE				
6	Pipe Adapter 3"	1100300	2	○
7	Exhaust Seal Clamp 3"	1100730	2	○
8	Pipe Adapter 3.5"	1100350	2	○
9	Exhaust Seal Clamp 3.5"	1100735	2	○
10	Pipe Adapter 4"	1100400	2	○
11	Exhaust Seal Clamp 4"	1100740	2	○
STEP #4 – MAIN SWITCH SELECTION				
12	Toggle Switch	1300201	1	○
13	Push / Pull Switch 5/8"	1300210	1	○
14	Push / Pull Switch 3/4"	1300211	1	○
15	Rocker Switch 5/8"	1030900	1	○
16	Rocker Switch 3/4"	1030910	1	○
17	Switch Cover (toggle only)	1302250	1	○

1137005 brake kit uses actuator 1133065 (65 pound spring)

1137000 brake kit uses actuator 1133060 (60 pound spring)

BD Engine Brake Inc.

Plant Address: 33541 MacLure Rd. Abbotsford, BC, Canada V2S 7W2

U.S. Shipping Address: 88-446 Harrison St, Sumas, WA 98295 U.S. Mailing Address: P.O. Box 231, Sumas, WA 98295

Phone: 604-853-6096 | Fax: 604-853-8749 | Internet: www.bd-power.com

Welcome

Thank you for purchasing a BD Engine Exhaust Brake. This manual is to aid you with your installation and operation of your braking unit. We strongly suggest that you fill out the information below and retain this manual for any future reference.

Application List

Part Number	Application	Year Range	Exhaust Size
1037133	Dodge Cummins	1989-1993	3.0" **
1037135	Dodge Cummins	1994-2002	3.5"
1037115	Chevy/GMC 6.5L	1994-2000	3.0-4.0" **
1037141	Ford 6.9L/7.3L IDI	1983-1994	3.0" **
1037142	Ford 6.9L/7.3L IDI	1983-1994	3.5"
1037144	Ford 7.3L Powerstroke	1994-2003	4.0"
1037143	Ford 7.3L Powerstroke Van	1994-2003	3.5"

**** Note: All 3" Brake Kits now come with a 4" marmon-style casting, and 4"->3" adapters for your exhaust. These adapters go on both sides of the valve assembly to adapt to your 3" exhaust.**

Options

Description	Part #
5/8" Manual Transmission Shifter Switch Kit	1300210
Brake Pressure Gauge Kit	CALL
Pyrometer Gauge Kit	1030512-I
Boost Pressure Gauge Kit (30 lb.)	1030570
Cockpit Gauge Mount (Single)	1030600
Molded Gauge Clusters (2 & 3 gauges)	CALL
Performance Torque Converter	CALL

BD Engine Brake Inc.

Plant Address: 33541 MacLure Rd. Abbotsford, BC, Canada V2S 7W2

U.S. Shipping Address: 88-446 Harrison St, Sumas, WA 98295 U.S. Mailing Address: P.O. Box 231, Sumas, WA 98295

Phone: 604-853-6096 | Fax: 604-853-8749 | Internet: www.bd-power.com

Valve Assembly Installation

In the engine compartment, locate the factory Vacuum Pump and if none is present (i.e. some 1988-93 Chevrolets), then the purchase of a BD Vacuum Pump kit (Part #1030120) is needed to supply the vehicle's retarding needs.

Inspect the vehicles exhaust system between the engine and the muffler. A straight section of pipe will have to be cut to accommodate the butterfly style valve of the Exhaust Valve Assembly, being approximately 7 to 8 inches. On 1994 or newer Dodges, the valve is mounted before the Catalytic Converter, on Ford and Chev/GM vehicles with Catalytic Converters, the valve is mounted between the Cat and muffler.

There should be no exhaust-flex pipe between the engine and exhaust brake valve, however, flex pipe is okay after the valve. Cut the exhaust pipe in a straight section of the system, you will need to weld one of the supplied adapters to the section of pipe coming from the front of the vehicle's engine.

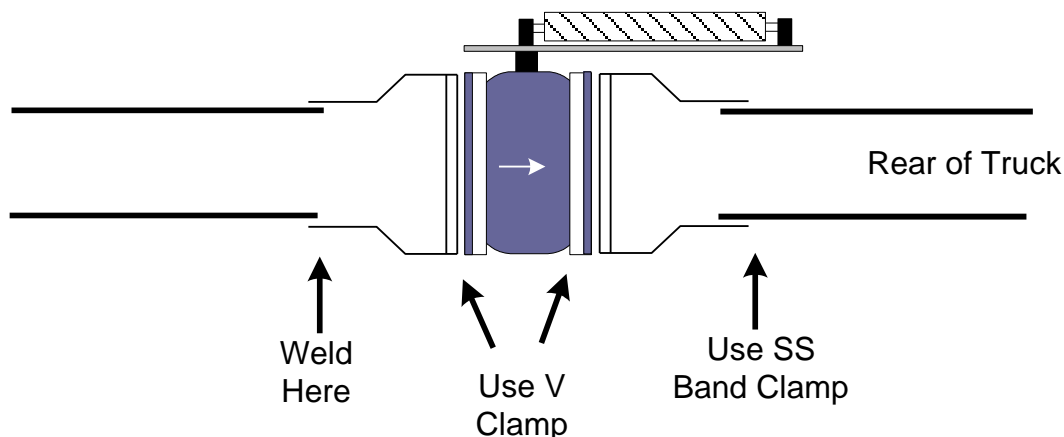

** Use supplied valve adapters (if applicable)*

Temporarily mount the exhaust valve assembly on the adapter, with the supplied V clamp on the valve sliding. From here, cut off as much of the remaining exhaust needed to accommodate the valve and remaining adapter. Remove the exhaust valve assembly and clamp, or weld the rear adapter to the other section of exhaust pipe.

Mount the exhaust valve assembly using the two supplied V-clamps, with the vacuum cylinder pointing away from the engine, and tighten the nuts and bolts.

NOTE: The arrow on the Exhaust Valve casting indicates exhaust flow, which should be pointed towards the rear of the vehicle (Figure 1).

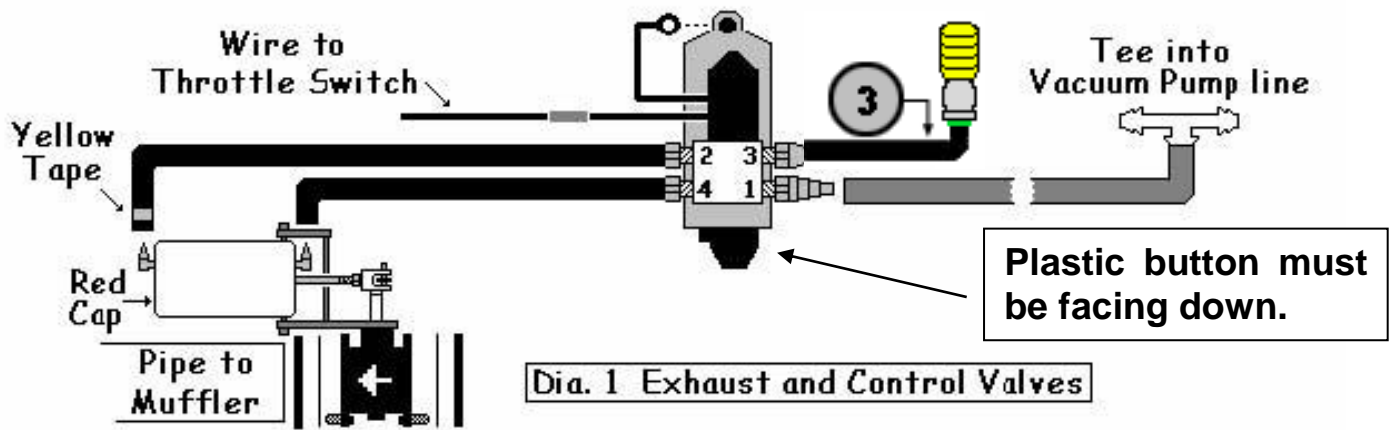

Control Valve Assembly

The control valve assembly has two hoses attached to it. Push the shorter piece onto the barbed fitting on the front cap of the vacuum cylinder on the exhaust valve assembly (see *Diagram 1*) and push the longer piece onto the barb fitting on the back cap (Red).

With the hoses now attached, locate or drill a new hole on the inner frame rail to mount the control valve assembly within reach of the hoses.

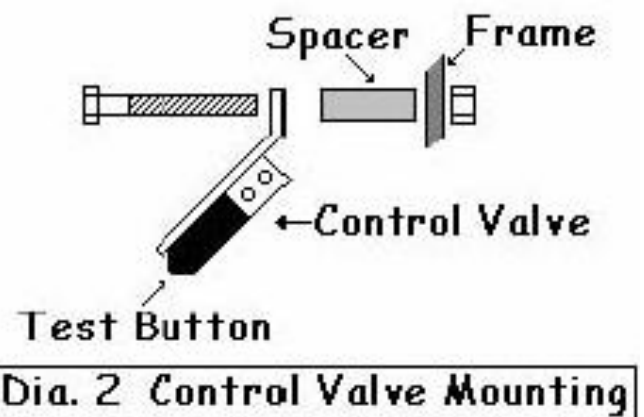

Existing holes or new holes will have to be drilled out to 5/16". Mount the control valve assembly to the frame using the long bolt, spacer and nut provided (*Dia. 2*). A good ground must be made when bolting bracket to frame rail.

There is a loose section of plastic hose that came included with the spool valve kit with a yellow plastic vent filter on it. Attach this to the spool valve (#3) and run to a dry location inside your cab. This vent prevents moisture from entering inside the control (spool) valve.

NOTE: If the vehicle has a vacuum assisted hydraulic brake booster or the vacuum pump is located on the driver side, then run the hose and wire along a cross member and up the driver's side frame rail.

In the engine compartment, locate the hose coming from the vacuum pump on the engine or to the vacuum assisted hydraulic Brake Booster. (On newer Chevrolets, the Air Conditioner Pump will have to be unbolted from its bracket and pushed off to one side.) Push the plastic tee (supplied in Application Kit) onto the hose coming from the Control Valve Assembly, and run hose to Vacuum Pump or Brake Booster.

BD Engine Brake Inc.

Plant Address: 33541 MacLure Rd. Abbotsford, BC, Canada V2S 7W2

U.S. Shipping Address: 88-446 Harrison St, Sumas, WA 98295 U.S. Mailing Address: P.O. Box 231, Sumas, WA 98295

Phone: 604-853-6096 | Fax: 604-853-8749 | Internet: www.bd-power.com

Cut the outlet hose of the vacuum pump or brake booster, no closer than 1" from the outlet fitting. Push both ends of the hose onto the plastic tee. Secure the hose with tie wraps and keep it clear of moving or heated parts.

Throttle Switch Installation

Ford Pick-up 1983-94 (Non-PowerStroke)

Mount the throttle switch on the bracket, with the silver button of the switch facing the rod of the Accelerator Pedal, so that the rod will hit the silver button when it is in its resting/idle position. Loosen the two lower nuts holding the Accelerator Pedal Assembly to the floorboard, slide the bracket all the way left under the nuts, using the two large grooves, and tighten (Dia. 3).

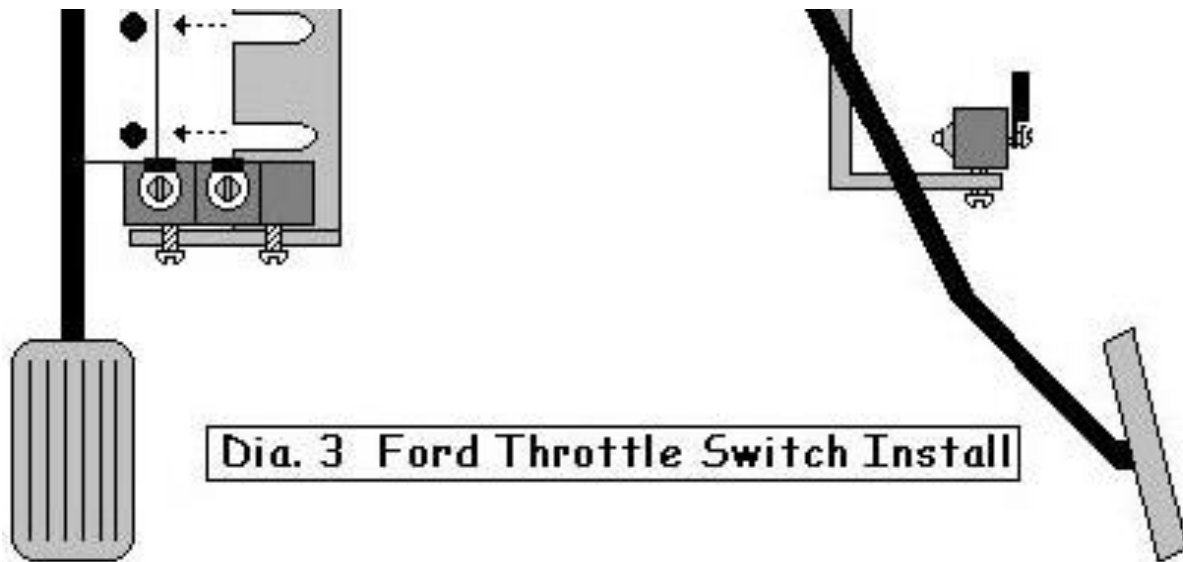

Ford PowerStrokes (1994-97) DFIV Wiring Diagram

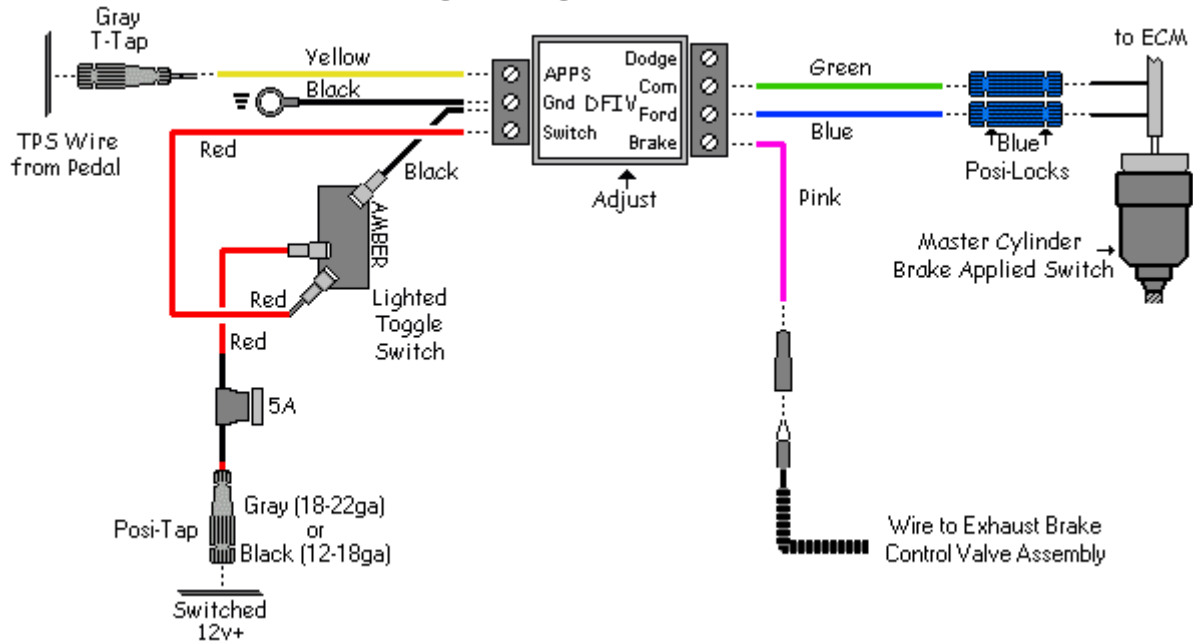

CAUTION: Before installing any wiring modifications or equipment, ensure to disconnect the battery ground (negative) terminals on all the vehicle batteries as damage to the vehicles ECU and/or installed components may result.

NOTE: If the vehicle does not have Cruise Control, remove the green and blue wire from the install and discard.

Remove the lower section of the drivers side dash, under the steering column, and mount the DFIV module to the cross member. Connect the black wire from the DFIV module to a good ground.

Locate one of the ignition switched red/black tracer wires under the steering column (one is 10/12ga and the other is 14/16ga) and connect an appropriate Posi-Tap connector to it (green for 10/12ga and black for the 14/16ga wire). Connect the fused red wire from the toggle switch to this Posi-Tap and mount the switch in a convenient spot on the dash.

Locate the Throttle Position Sensor (TPS) at the throttle pedal. Use a Posi-Tap connector to attach the yellow wire from the DFIV module to the red wire w/gray tracer wire (1994-1997 trucks) to the TPS.

Ensure the green wire is connected to the '**COM**' terminal of the DFIV module, the blue wire is connected to the '**FORD**' terminal of the DFIV module, and the pink wire is connected to the '**BRAKE**' terminal of the DFIV module. Also check to ensure all other wires at the DFIV module are secure.

BD Engine Brake Inc.

Plant Address: 33541 MacLure Rd. Abbotsford, BC, Canada V2S 7W2

U.S. Shipping Address: 88-446 Harrison St, Sumas, WA 98295 U.S. Mailing Address: P.O. Box 231, Sumas, WA 98295

Phone: 604-853-6096 | Fax: 604-853-8749 | Internet: www.bd-power.com

Run the other end of these wires through a grommet on the firewall making sure all wires are secure and away from moving objects and heat sources. Go to page 11 and follow the instructions to calibrate the DFIV module.

Chevrolet/GMC (1994-2000) 6.5L Trucks

Below the throttle pedal you will need to remove the two nuts below the potentiometer, holding the Accelerator Pedal Assembly to the floor board, and mount the throttle switch bracket to the Accelerator Pedal Assembly with the two screws so that the bracket angles off to the right.

Mount the throttle switch on the bracket, with the silver button of the switch facing the rod of the Accelerator Pedal, so that the rod will hit the silver button when it is in its resting/idle position. (Similar to Dia. 3)

Chevrolet/GMC (1982-93) 6.2/6.5L and Generic Applications

The throttle switch assembly consists of an "L" shaped bracket and a switch with a long flexible arm; the switch is activated when the flexible arm is moved. Mount the bracket and switch around the accelerator pedal, so that when the accelerator comes back to it's resting/idle position, the pedal arm presses against the flexible arm of the switch.

Dodge 1988-1993

The Throttle Switch Bracket mounts behind the throttle linkage using the two bolts used for mounting the throttle linkage to the engine (*Diagram 6*). On all years, if throttle return spring(s) are weak, another spring may have to be installed.

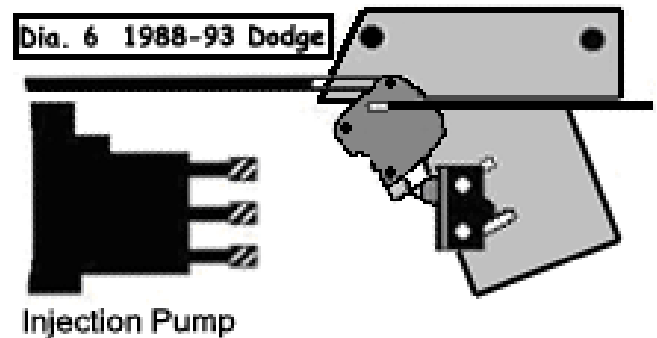

Dodge 1994 to 1998 12V

Place the Throttle Switch on the bracket by using the two bolts of the engine front cover by the injection pump throttle linkage (*Diagram 5*). Every time the throttle is released the linkage should actuate the micro switch by slightly touching it.

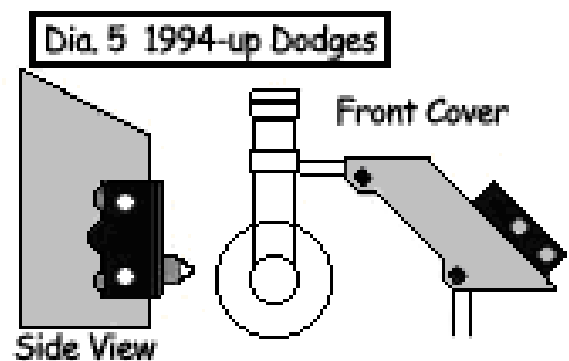

Dodge 1998 to 2002 24V

These models of Cummins trucks have been upgraded to use the **DFIV** (Dodge/Ford Idle Verifier) system. This system electronically senses the throttle position via the **APPS** (Accelerator Pedal Position Sensor) output circuit.

Dodge 2001-2002 HO 6spd (ONLY)

To obtain access to the Cruise Control wiring harness, remove the lower steering column panel by removing the mounting screws and unsnapping the panel from the instrument panel.

Under the dash running vertical by the left of the steering column, locate the smaller wiring harness that runs out of the main harness.

Remove some of the black electrical tape to gain access to the smaller wire bundle.

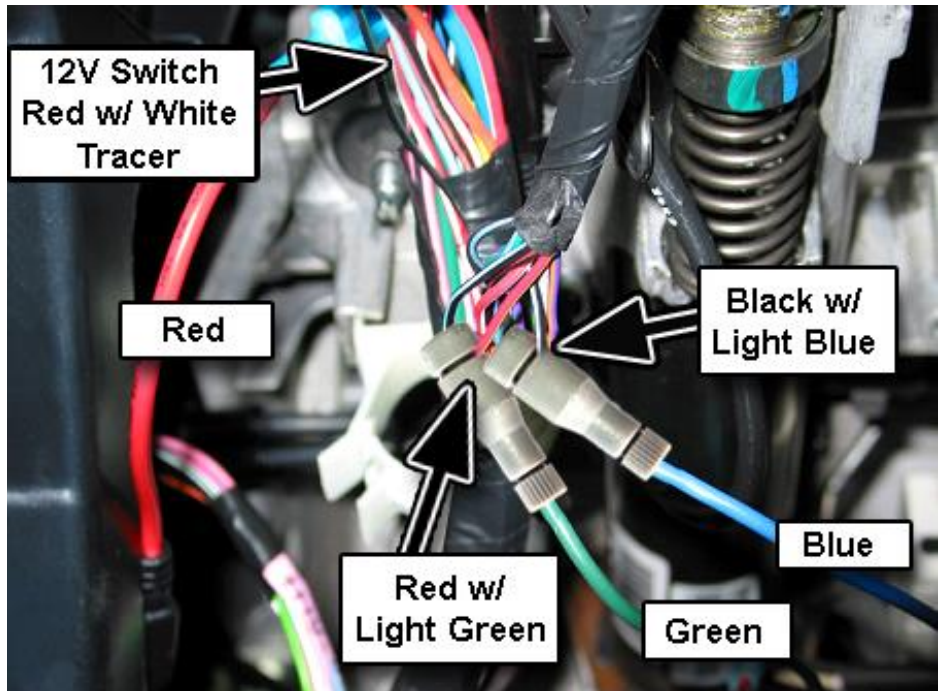

*****DANGER*****

THERE IS A BLACK WIRE WITH A TWISTED LIGHT BLUE/GREEN TRACER DO NOT CONNECT OR TEST THIS WIRE AS IT IS CONNECTED TO THE AIR BAG AND THE BAG MAY DEPLOY CAUSING DAMAGE AND/OR INJURY!

*****DANGER*****

Remove some of the black electrical tape from the small bundle to gain access to the small Black wire with Light Blue tracer and install a gray Posi-Tap™ to it. Insert the Blue wire from the DFIV module into this connector.

In this same wiring harness, locate the Red wire with Light Green tracer and install another gray Posi-Tap™. Insert the Green wire from the DFIV module into this connector.

Go to page 11 for the DFIV calibration instructions.

BD Engine Brake Inc.

Plant Address: 33541 MacLure Rd. Abbotsford, BC, Canada V2S 7W2

U.S. Shipping Address: 88-446 Harrison St, Sumas, WA 98295 U.S. Mailing Address: P.O. Box 231, Sumas, WA 98295

Phone: 604-853-6096 | Fax: 604-853-8749 | Internet: www.bd-power.com

Dodge DFIV Wiring Diagram (1998½ - 2002)

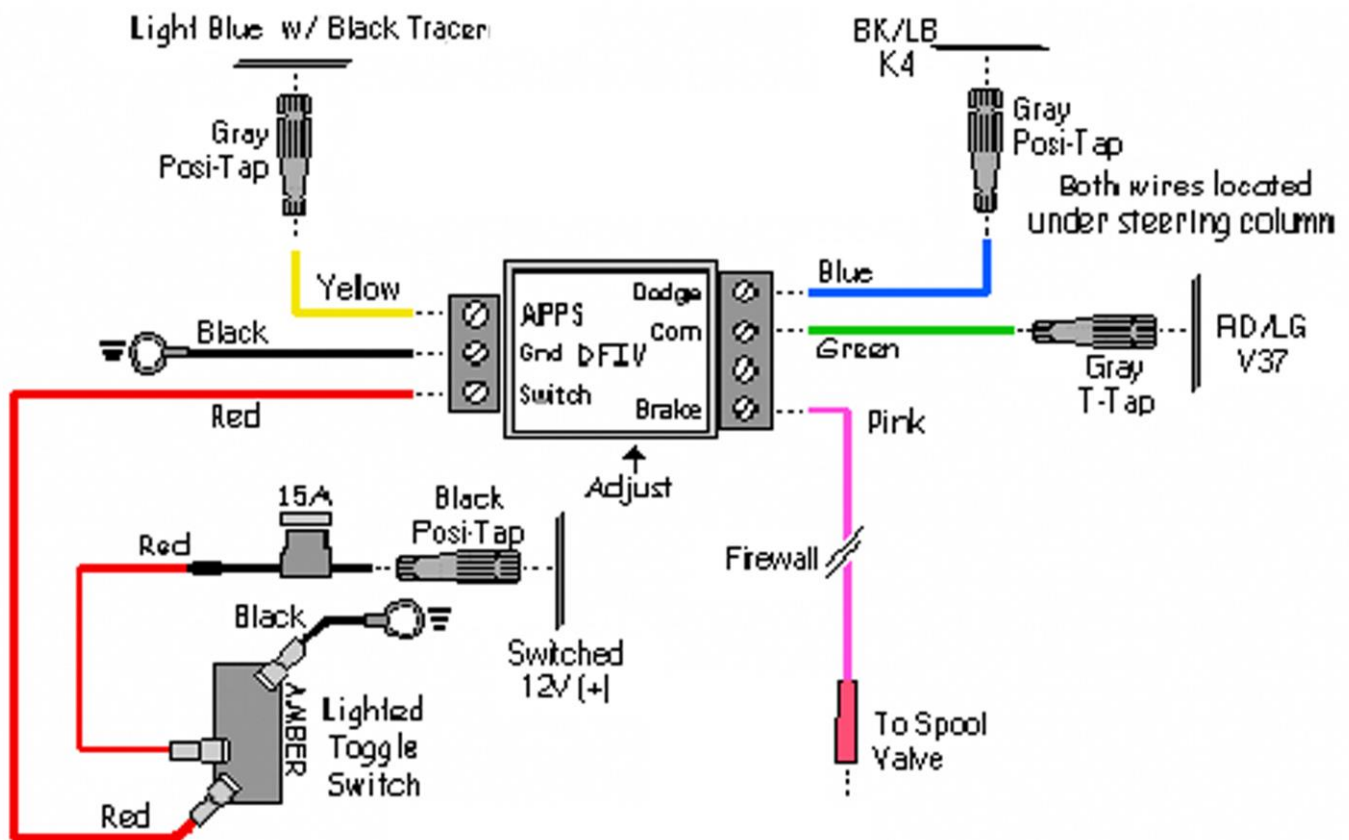

On all throttle switch applications (except PowerStrokes):

Manually move the linkage back and forth to make sure the proper activation to the throttle switch is occurring. The throttle switch may have to be adjusted on occasion.

NOTE: With mechanical injection pump systems, the linkage is moved during cruise control and/or fast idle operations, so the brake will not be activated during these occurrences.

Run the wire coming from the Control Valve Assembly through the fire wall (except Dodge and Cummins Trucks & Motorhomes) and to the Throttle Switch; using an electrical connector, hook up wire to the top screw on switch, or on Ford PowerStrokes, free terminal (#87a) on relay.

For Dodge and Cummins Trucks & Motorhomes, run wire over to Throttle Switch, cut wire and connect to the top terminal with an electrical connector.

BD Engine Brake Inc.

Plant Address: 33541 MacLure Rd. Abbotsford, BC, Canada V2S 7W2

U.S. Shipping Address: 88-446 Harrison St, Sumas, WA 98295 U.S. Mailing Address: P.O. Box 231, Sumas, WA 98295

Phone: 604-853-6096 | Fax: 604-853-8749 | Internet: www.bd-power.com

DFIV Calibration

-- For 1999-2002 Ford Powerstrokes and 1998-2002 Dodge Cummins model trucks.

Ensure the connections of the corresponding wires to the DFIV Control Module are correct as shown in the wiring diagram.

To achieve the correct setting for the activation of the exhaust brake in relation to the throttle pedal the DFIV Module must be calibrated for your vehicle.

Connect one end of a test light to the "BRAKE" terminal of the DFIV module and the other end to a good ground. With the throttle at idle, start the engine and turn on brake switch. Then, using a small flat bladed screwdriver, turn the small adjusting screw in the DFIV Module



counterclockwise or clockwise until the test light JUST turns on.

CAUTION: THE ADJUSTING SCREW IS A MICRO-SWITCH THAT IS VERY DELICATE, SO TURN USING SMALL ADJUSTMENTS.

Test by revving up the engine to approximately 1200 RPM and releasing the throttle. As the accelerator pedal is applied the test light should turn off just before the engine starts to rev, indicating proper calibration of the DFIV Module with the APPS.

Then the test light should activate again when the throttle pedal returned to idle. If not, readjust the DFIV Module so that it does. Reinstall lower dash cover.

Power and Toggle Switch

Mount the toggle switch in a convenient and secure location on the dash. Locate a 12v ignition switched source (fuse panel or wire), then connect the in-line fuse holder to the source line or use the fuse tapper (Diagram 7).

This power line should be connected to the middle terminal of the toggle switch. Ground the black wire from the upper switch terminal marked amber. Connect the lower switch output terminal to the middle position on the micro switch

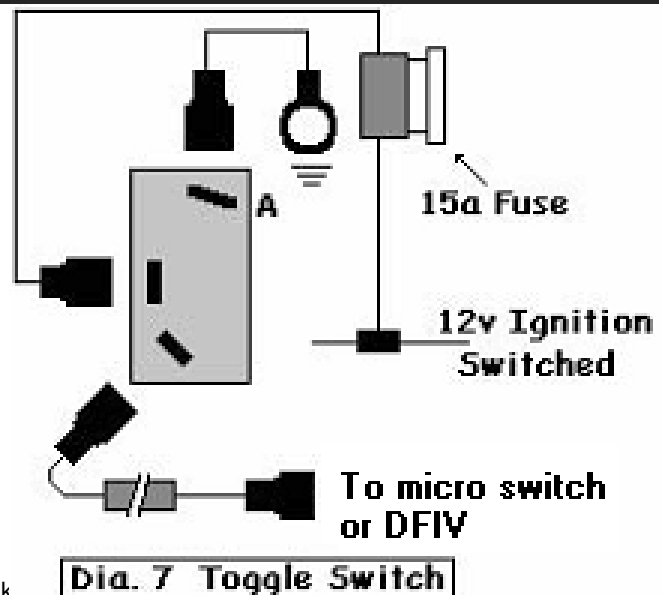

BD Engine Brak

Plant Address: 33541 MacLure Rd. Abbotstord, BC, Canada V2S 7W2

U.S. Shipping Address: 88-446 Harrison St, Sumas, WA 98295 U.S. Mailing Address: P.O. Box 231, Sumas, WA 98295

Phone: 604-853-6096 | Fax: 604-853-8749 | Internet: www.bd-power.com

mounted to throttle. Connect the remaining terminal on the micro switch to the exhaust brake control valve you mounted earlier. Route this wire away from any heat sources or moving parts.

For Powerstroke applications the toggle switch and the manual shifter switch should control power to the DFIV. When the brake is engaged 12V should be provided to the switched input of the DFIV. See previous drawing.

Cruise Control Disable

Chevrolet/GMC Cruise Control Disable

For 1994-up Chevrolets you will need to utilize the relay that is provided in the kit to connect the cruise control disable system. On 1994-up Chevrolets, right below the steering column, under the dash, there is a wire connector assembly with a large amount of wires connected to it.

One of the purple wires leads up to another 8-pin connector just above it. You can verify the wire by tapping the wire with a test light and grounding the clip; with the ignition turned on the light should be illuminated, but no light when you press on the brake pedal. Cut this wire and connect both ends (see *Diagram 9*) to the purple (or blue) wires coming from the supplied relay using non-insulated butt connectors and shrink wrap.

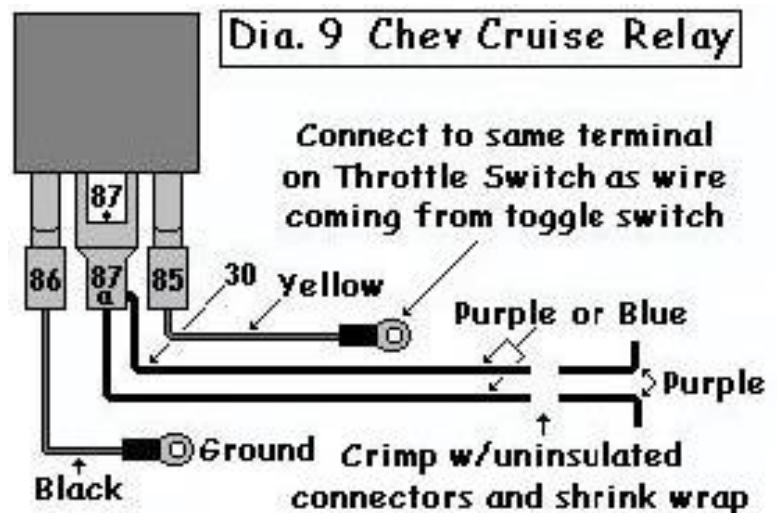

The yellow wire from the relay connects to the same terminal on the Throttle Switch as the wire coming from the toggle/shifter switch. Mount the relay under the dash and ground the Black wire.

Ford Powerstroke

Locate the black w/yellow tracer wire at the cruise control disable (Brake Applied) switch located on the brake master cylinder and expose the wiring approximately 4-6 inches from the switch to allow for a good length to work with. This wire may be a different color in various applications. If there is no black w/yellow wire going to this switch, then use a test light to check which wire changes state (power to no power) when the brake pedal is applied.

Cut the black w/yellow tracer wire (BK/Y), then strip both ends and attach a separate blue Posi-Lock connector on each end of the cut wire. Run the green and blue wires that were brought through the firewall to the Brake Applied Switch at the brake booster and cut off any excess. Attach these wires to the two blue Posi-Lock connectors that you have just installed to the Black wire w/Yellow tracer.

Dodge Cruise Disable

2000 to 2002 (245HP HO 6 Speed) (Only):

NOTE: IF INSTALLING A BD TOWLOC WITH THIS BRAKE, DO NOT INSTALL DFIV FROM THIS SECTION. FOLLOW THE TOWLOC DIRECTIONS FOR THE SWITCH TO CONTROL THIS BRAKE

To obtain access to the Cruise Control wiring harness remove the lower steering column panel by removing the mounting screws and unsnapping the panel from the instrument panel.

Under the dash running vertical by the left of the steering column, locate the smaller wiring harness that runs out of the main harness.

Remove some of the black electrical tape to gain access to the smaller wire bundle.

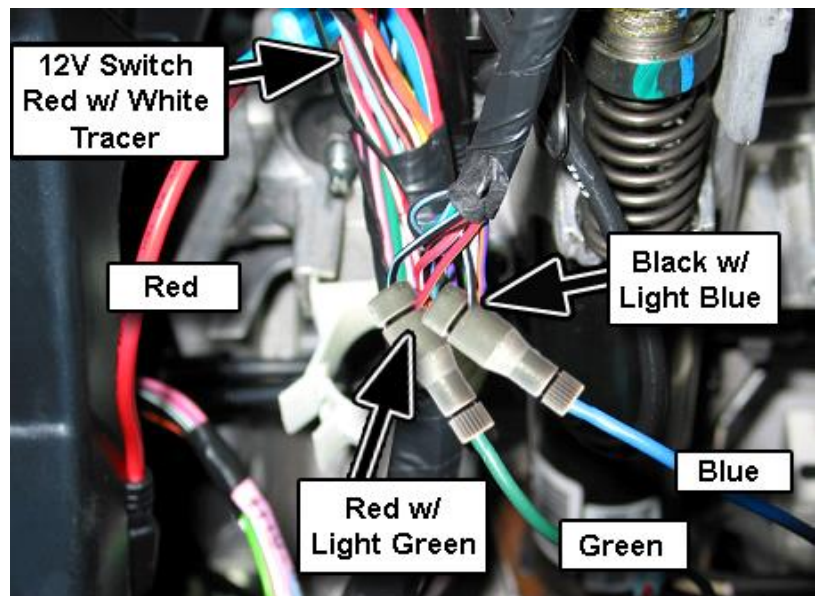

*****DANGER*****

THERE IS A BLACK WIRE WITH A TWISTED LIGHT BLUE/GREEN TRACER DO NOT CONNECT OR TEST THIS WIRE AS IT IS CONNECTED TO THE AIR BAG AND THE BAG MAY DEPLOY CAUSING DAMAGE AND/OR INJURY

*****DANGER*****

Remove some of the black electrical tape from the small bundle to gain access to the small Black wire with Light Blue tracer and install a gray Posi-Tap™ to it. Insert the Blue wire from the DFIV module into this connector.

In this same wiring harness, locate the Red wire with Light Green tracer and install another gray Posi-Tap™. Insert the Green wire from the DFIV module into this connector.

BD Engine Brake Inc.

Plant Address: 33541 MacLure Rd. Abbotsford, BC, Canada V2S 7W2

U.S. Shipping Address: 88-446 Harrison St, Sumas, WA 98295 U.S. Mailing Address: P.O. Box 231, Sumas, WA 98295

Phone: 604-853-6096 | Fax: 604-853-8749 | Internet: www.bd-power.com

Exhaust Brake Routing Diagram

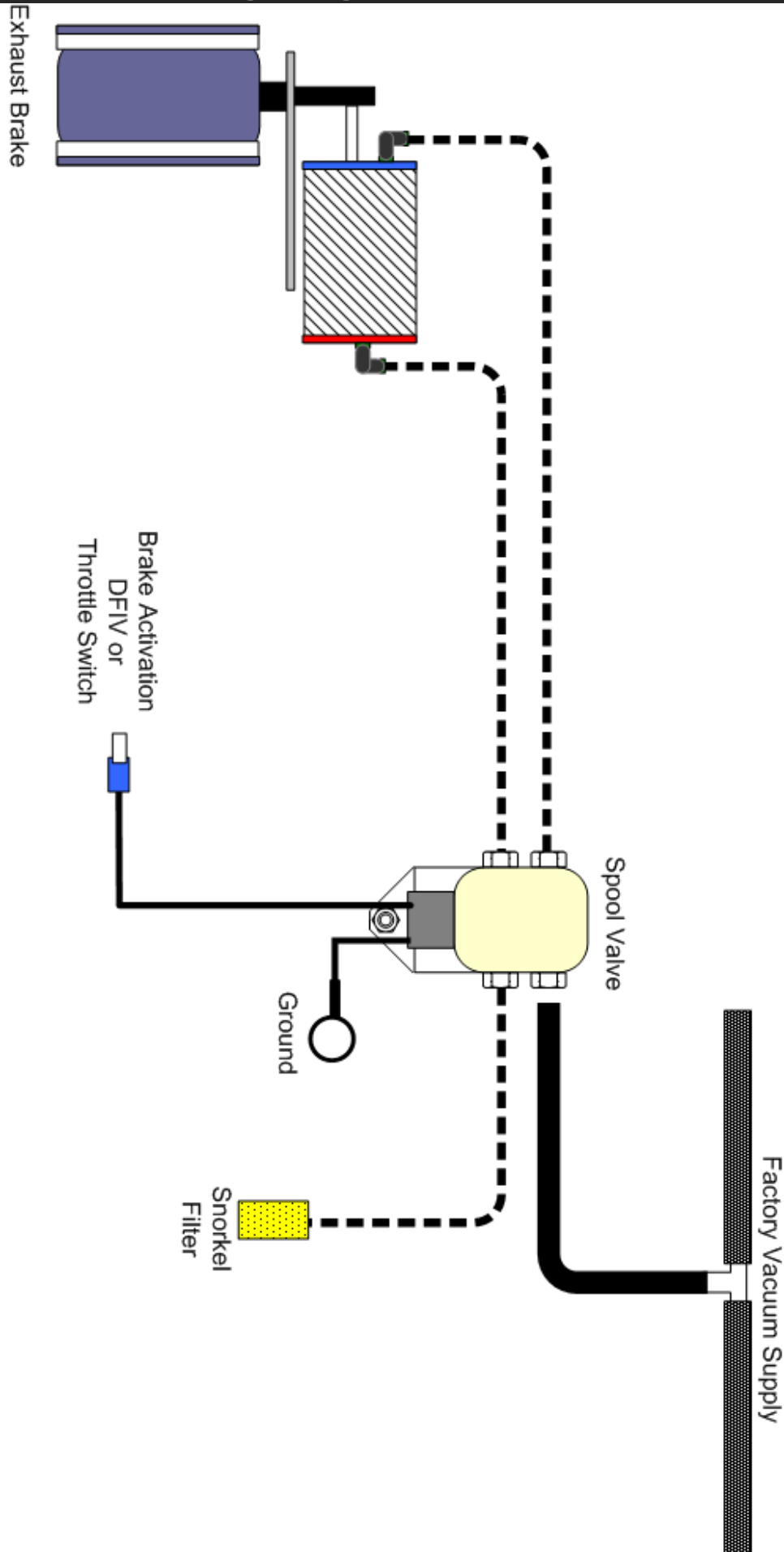

BD Engine Brake Inc.

Plant Address: 33541 MacLure Rd. Abbotsford, BC, Canada V2S 7W2

U.S. Shipping Address: 88-446 Harrison St, Sumas, WA 98295 U.S. Mailing Address: P.O. Box 231, Sumas, WA 98295

Phone: 604-853-6096 | Fax: 604-853-8749 | Internet: www.bd-power.com

Optional Manual Shifter (Push-Pull Style)

Mount the push/pull switch on the shifter lever (Diagram 10), using the switch clamp, and secure the cable on to the lever.

NOTE: Keep cable away from spots where it could get pinched during shifting. Strip the ends of the wires and attach male blade connectors to each.

Slip off the Red wire from Toggle Switch and attach to Black wire of Manual Shifter Switch cable, and, slip off the Yellow wire from Toggle Switch and attach to White wire of cable. Discard Toggle Switch and its black wire. Attach the Yellow wire to the middle terminal of Throttle pedal Switch or the 12V Switched input of the DFIV.

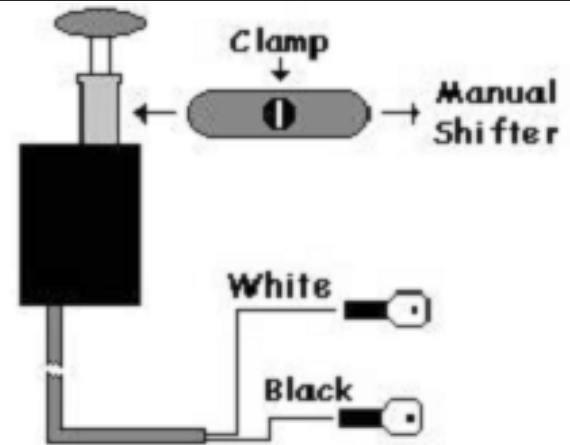

Dia. 10 Shifter Switch

Optional Brake Pressure Gauge

For the optional Brake Pressure Gauge, push tubing through firewall. The kit comes with a bracket to mount the gauge under the dash, but it could be mounted in any optional 2" gauge mount.

Connect the black plastic tubing to the back of the gauge using a 1/8npt female compression fitting. Using electrical connectors, connect the wire coming from the light bulb holder to a power source, preferable to one that is switch by the head light switch, and connect a ground wire to the mount screws of the gauge. Mount the gauge in the desired location.

Testing

Start up the engine and turn the toggle switch on to make sure the brake activates. Depress the throttle pedal and let up on it to check that operation of the throttle switch, allowing the brake to engage when the throttle is in the resting/idle position.

Using a standard pressure gauge, follow the list below for proper setting, with the engine running at idle and brake turned on.

Vehicle	Lbs.	Pressure @ Idle
Chevy 6.2/6.5L & Ford 6.9/7.3L	32lbs.	8-10 lbs.
Ford Powerstroke & Dodge Cummins	40lbs.	10-12 lbs.
Dodge Cummins w/ 60lb. exhaust springs	60lbs.	18-20 lbs.

If the brake pressure does not fall within these limits, please call the BD Engine Brake technical hotline at (800) 887-5030.

Be sure to test the cruise control disconnect system while test-driving the 1994 and newer Ford PowerStrokes and Chevrolet 6.5L engines. Set the cruise at a safe speed and then turn the exhaust brake on, which should turn the Cruise Control off right away.

If the cruise control does not disengage right away, then turn the exhaust brake off immediately.

If the cruise control did disengage, then turn the exhaust brake off and hit the resume function on the cruise control switch to see if the cruise will re-engage.

BD Engine Brake Inc.

Plant Address: 33541 MacLure Rd. Abbotsford, BC, Canada V2S 7W2

U.S. Shipping Address: 88-446 Harrison St, Sumas, WA 98295 U.S. Mailing Address: P.O. Box 231, Sumas, WA 98295

Phone: 604-853-6096 | Fax: 604-853-8749 | Internet: www.bd-power.com

Vacuum Brake Troubleshooting Guide

This guide assumes that your exhaust brake system is using a DFIV. If your system uses a microswitch for throttle activation, the operation of the spool valve is the same as with the DFIV. Always check to make sure the vehicle's vacuum system is operating correctly and is free of leaks. Most systems will produce approximately 15in/Hg (inches of mercury), or 7.5psi absolute, at sea level.

When I let off the throttle nothing happens.	<u>No</u>	<u>Yes</u>
<p>Check vacuum supply to the spool valve.</p> <p>Is the DFIV powering the "brake" output wire when the throttle is at idle and brake switch and ignition are both on?</p>	<p>Check that DFIV has good power, ground and throttle signal.</p> <p>Check DFIV adjustment.</p> <p>If all these things check out, but the DFIV won't power the "brake" wire, the DFIV is likely faulty.</p> <p>Also check for a good ground at the spool valve.</p>	<p>Check that when spool valve is powered it switches vacuum output from the hose going to the rear of the vacuum cylinder to the hose going to the front of the cylinder (the end that the rod comes out of).</p>
The brake comes on but there's little or no holdback	<u>No</u>	<u>Yes</u>
<p>Check that torque converter is staying locked up. If it is not, the engine RPM will fall to idle when the throttle is released.</p> <p>Check off-idle brake backpressure. Are you getting maximum allowable backpressure? (See backpressure chart)</p>	<p>Check for exhaust leaks. A small leak can result in a significant decrease in brake backpressure. Check for vacuum leaks.</p>	<p>Try down shifting more aggressively. More RPM will give more holdback. Vacuum systems will decrease in effectiveness with an increase in altitude. For example at 5000ft a 60psi brake will only make about 50psi exhaust backpressure. Transmission or torque converter could be slipping internally.</p>
Everything seems to work, but the brake valve won't close.	<u>No</u>	<u>Yes</u>
<p>Check that vacuum is reaching the front hose (near where the rod comes out) of the brake cylinder.</p>	<p>Spool valve stuck, plugged or faulty. Clean or replace as required.</p>	<p>Cylinder or brake valve are seized. Remove the clevis pin on the end of the cylinder rod & see if the valve lever can be moved freely.</p>
<p>The valve lever can be moved freely.</p>	<p>Try dismounting the brake & cleaning the carbon out of it. If this does not work the brake valve will need to be replaced.</p>	<p>The cylinder is stuck and will need to be replaced.</p>
Problem	Solution	
<p>Air compressor runs in short bursts and brake is slow to apply.</p>	<p>There is a restriction in the air system, normally in the regulator or air solenoid. Remove the fittings from the regulator and air solenoid, you will likely find some corrosion or debris caught in them. Clean this out with a pick, small brush, compressed air and WD40 or similar lubricant.</p>	
<p>Air compressor runs continually.</p>	<p>Pump relay is likely stuck on. Check operation of relay & replace as required.</p>	
<p>Brake is slow to release.</p>	<p>Debris or corrosion is restricting the quick release valve or air solenoid. Clean as required. Air solenoid could be too far from brake.</p>	

BD Engine Brake Inc.

Plant Address: 33541 MacLure Rd. Abbotsford, BC, Canada V2S 7W2

U.S. Shipping Address: 88-446 Harrison St, Sumas, WA 98295 U.S. Mailing Address: P.O. Box 231, Sumas, WA 98295

Phone: 604-853-6096 | Fax: 604-853-8749 | Internet: www.bd-power.com

Operating Guidelines

Thank you for taking interest in the BD Engine Exhaust Brake. As a driver, you probably already know the need for extra braking power that your vehicle requires on the hills and long grades. With loads being towed behind you, the extra push when slowing down or maintaining speed on downward grades can prove to be a great strain on your vehicles chassis's braking system, even to the point of "burn-up". These guidelines were designed to offer you a better understanding of the benefits of exhaust brakes and are partly based upon material developed by the U.S. Department of Transportation National Highway Traffic Safety Administration.

The emphasis on today's vehicles is to give the consumer a product that can give them usable power with fuel efficiency. But, in the transition, the vehicles have lost their natural braking power, making it more easy for the vehicle to continue to roll and harder to stop. Of course, this gets more noticeable with the increase of weight, on or behind the vehicle. This is where an exhaust brake becomes a useful tool for increasing the driveline drag of the vehicle without the use of the chassis's brakes. A tool, which with maximum or even occasional use can reduce wear on chassis' braking parts and at the same time increase safety.

The BD Exhaust Brake can be used to help maintain a controlled vehicle speed on a downward grade, as well as slowing the vehicle down for such times as turns or exit ramps, without you using your chassis's brakes. But, the exhaust brake cannot be used as a parking brake or will not bring your vehicle to a complete stop.

By using a BD Exhaust Brake, the life and effectiveness of your chassis's brakes will increase. This is because of the decreased use of the chassis's brakes in situations like hills, the wear factor is reduced and there is less opportunity for your chassis's brakes to heat up which would reduce the efficiency.

When you ride your chassis's brakes, make hard stops or have poorly adjusted brakes, this creates high temperatures and as your brakes get hotter, the more chance there is for fade or failure.

With terrain that is a series of up and down grades, the BD Exhaust Brake will aid in reducing exhaust valve warpage. Because of the power needed to pull your vehicle and load up a hill, this generates a lot of heat. When you have reached the crest of the hill and are now coasting down the other side, the heated valves are too quickly cooled. With the exhaust brake engaged, the heat loss to the valves will be reduced, which can prevent valve warpage.

When the toggle switch is turned to the "On" position, the valve is activated every time the driver takes his foot off of the throttle pedal. When the driver puts pressure back on the throttle pedal, the throttle switch is deactivated and the valve opens again.

BD Engine Brake Inc.

Plant Address: 33541 MacLure Rd. Abbotsford, BC, Canada V2S 7W2

U.S. Shipping Address: 88-446 Harrison St, Sumas, WA 98295 U.S. Mailing Address: P.O. Box 231, Sumas, WA 98295

Phone: 604-853-6096 | Fax: 604-853-8749 | Internet: www.bd-power.com

Exhaust brakes are designed to operate with the throttle at idle, not to be used in conjunction with cruise controls, and not designed to aid in gear shifting. Such cases could cause damage to engine and/or the exhaust brake.

Incorporated with the BD Exhaust Brake, there is a pressure regulating system that will control the created backpressure. If the backpressure reaches the set limit, the exhaust valve will open slightly to relieve the excess pressure.

The brake pressure at idle is required to be checked and adjusted at time of installed, two weeks after installed, and on a regular twice a year interval.

For Ford IDI and Chevy vehicles adjust the brake pressure to 8-10lb at idle; and Ford PowerStrokes, adjust to 10-12lb at idle.

On Dodge 6BTA (1989-98) with the stock exhaust valve springs, adjust the idle pressure to 10-12lb at idle, and if the heavy duty valve springs have been installed, adjust idle pressure to 18-20lb at idle. Dodge ISB (1998-up), adjust idle pressure to 18-20lb at idle.

If you have purchased a system that is rated for the stock engine exhaust valve springs, and you later decide to update to the heavy duty exhaust valve springs, you will have to adjust the brake pressure to 20-25lb at idle.

Never adjust the brake to the 60 lb. setting on an engine that has not had the heavy-duty engine exhaust valve springs installed first.

With the normal mounting position of the Control Valve Assembly being on the frame rail, it would make it exposed to water if driven through rivers, creeks, or deep bodies of water. If the Exhaust Brake is being used during these situations, water could be sucked through the venting filter and eventually into the Vacuum Cylinder, damaging booth. For the best prevention of this damage, do not operate the brake during these occurrences.

The best scenario for exhaust braking is when going down hill, select a gear that lets you maintain a constant speed with little or no use of the chassis's brakes, or the same gear that would be used to go up the same grade of hill. This also depends on the weight, load or road conditions that the vehicle will come upon.

So, in summary, by using the BD Exhaust Brake, you reduce the need for use of your chassis's brakes in situations where you need to slow down or maintain (i.e. hills, off ramps, approaching speed changes or traffic lights). By reducing the use of your chassis' brakes, in these situations, the heat build up is reduced, as well as wear and damage to linings and drums. And, when you reduce these factors, you

BD Engine Brake Inc.

Plant Address: 33541 MacLure Rd. Abbotsford, BC, Canada V2S 7W2

U.S. Shipping Address: 88-446 Harrison St, Sumas, WA 98295 U.S. Mailing Address: P.O. Box 231, Sumas, WA 98295

Phone: 604-853-6096 | Fax: 604-853-8749 | Internet: www.bd-power.com

save your chassis's brakes for when you really need them (i.e. for stopping or emergencies).

The BD Exhaust Brake is not a substitute for your chassis's brakes and, cannot correct or compensate for poorly maintained or misadjusted brakes. But, when you need to slow down or maintain a constant speed, the BD Exhaust Brake will be a valuable and effective tool. Exhaust Brakes are more efficient at preventing than correcting an over speed condition.

To increase the life of your exhaust brake we recommend daily operation. This could simply be switching it on and off a couple times a day. This will prevent the butterfly from sticking due to carboning up.

Thank you and happy motoring,

BD Engine Brake, Inc.

BD Engine Brake Inc.

Plant Address: 33541 MacLure Rd. Abbotsford, BC, Canada V2S 7W2

U.S. Shipping Address: 88-446 Harrison St, Sumas, WA 98295 U.S. Mailing Address: P.O. Box 231, Sumas, WA 98295

Phone: 604-853-6096 | Fax: 604-853-8749 | Internet: www.bd-power.com