



# TITANIUM SIGNATURE SERIES INSTALLATION MANUAL

## ALL 1/2" FUEL PORTS

### APPLICATION:

**TS-D07-100G**  
**(100GPH @ 16-18PSI)**  
**TS-D07-165G**  
**(165GPH @16-18PSI)**

**Cummins 5.9L/6.7L**  
**24 Valve**

**Standard Pickup Truck**  
**2005-2018**  
**1998.5-2004**  
**2021-2023 (CP3)**

**\*with In-tank Lift Pump**  
**\*NOTE: CAB AND CHASSIS MAY REQUIRE MODIFICATIONS**

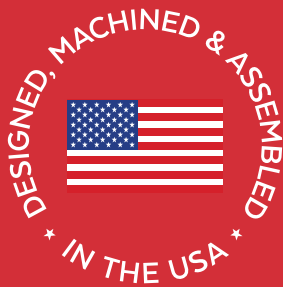



[www.fassride.com](http://www.fassride.com)

(866) 769.3747

## **Thank you for choosing FASS, from Diesel Performance Products, Inc.**

FASS specializes in building extremely high-quality fuel products. We have earned an unsurpassed reputation for excellence in our industry by using only the highest-quality American-made components. In order to support our American workers and our American economy, more than 98+ percent of our products are manufactured completely in the United States.

Of course, that dedication to excellence comes at a price, but it is important to remember that price does not dictate quality-quality dictates price! We will never compromise by using cheaper, foreign-made components, like so many of our competitors do.

Customer satisfaction is our top priority and we strive always to provide outstanding customer service. Our Research and Development department, in conjunction with our Dealer Support Department, continually searches for ways to improve quality, expand our product line, and provide superb support. Our exclusive ViP Network ensures that customers receive the proper products and support at the local level. The extended lifetime warranty is only available on products purchased from the network. There is no warranty on products not purchased outside the network.

## **IMPORTANT:**

*In order to qualify for the lifetime extended warranty, your product registration form and proof of purchase from an authorized dealer must be submitted to FASS Fuel Systems within 30 days of purchase. Failure to comply will void the warranty. We have the right to deny any warranty believed to be false, altered or purchased through an unauthorized or terminated dealer. A current list of authorized dealers can be found on our website, [FASSRide.com](http://FASSRide.com).*

The complete conditions of the Limitation of Warranty can be found in the back of this manual, and [FASSRide.com](http://FASSRide.com).

**For more information,  
contact Technical Support:  
Diesel Performance Products, Inc.  
16234 State Hwy O Marthasville,  
MO 63357  
636-433-5410**



**WARNING!**

**This product has NO WARRANTY unless:**

**1. It has been purchased from an **Authorized** or **ViP FASS Dealer**. If in doubt, check [www.FASSRide.com](http://www.FASSRide.com).**

**2. It is registered within thirty (30) days of purchase.**

**Other conditions may apply. Please see full warranty information.**

***NOTE:* Warranty is **void** if product was purchased below FASS website advertised pricing.**

**ATTENTION!**

**Before you begin installation**

**Register for your Warranty ONLINE at**

**<https://www.fassride.com/register-a-warranty/>**

**No online access, call our TECH Support at**

**1-866-769-3747**

# FOLLOW THESE STEPS TO ENSURE A SIMPLE, CORRECT INSTALLATION OF YOUR NEW TITANIUM FUEL SYSTEM

## ATTENTION:

**Be sure to identify the proper FASS System and fuel line configuration. For help, our product finder can be found at [www.FASSride.com](http://www.FASSride.com). Follow the instructions to see fuel line detail.**

- 1** Be sure the serial number on this installation manual matches that on the outside of the box.
- 2** Pay close attention to ALL WARNINGS
- 3** Read all instructions before starting installation of this product.
- 4** Inventory the package components. Notify the place of purchase immediately of any parts missing or damaged.
- 5** The installation recommendations contained herein are guidelines. Use good judgment and take into consideration your vehicles' accessories.
- 6** For best results in accuracy and efficiency (due to training, communication, and our relationship with our dealer network), we recommend a VIP FASS dealer for the installation. They are prepared to install the FASS fuel pumps with the most efficiency. If a situation or problem arises during the installation, the dealer is prepared to handle it. Diesel Performance Products, Inc. is not responsible for any installation mistakes.
- 7** If you have any questions or concerns that cannot be addressed with your dealer, email or call FASS.

---

**If any installation procedure is uncertain, contact FASS technical support.  
Call customer service at 636-433-5410,  
or send us an e-mail: [techsupport@FASSride.com](mailto:techsupport@FASSride.com)  
with the following information:**

---

Your name, address and daytime phone number  
Model **(TS-D07-100G)** or **(T-D07-165G)**  
Serial Number  
Last 6 digits of vehicles' VIN

Date of purchase  
Nature of Your Concern  
Serial number .....



# INSTALLATION MANUAL

## **TS-D07-100G or TS-D07-165G**

(Installation Videos are available at [www.fassride.com](http://www.fassride.com))

### **Recommended Application**

**TS-D07-100G:** Cummins 2005-2018 & 2021-2023 with stock - 600 horsepower

**TS-D07-165G:** Cummins 2005-2018 & 2021-2023 with 600 - 1,000 horsepower

**NOTE: THIS KIT MAY ALSO BE USED ON 1998.5-2004 CUMMINS WITH IN-TANK LIFT PUMP MODIFICATIONS**

1. Read all instructions before starting installation of this product!
2. Installing the improper FASS Pump can cause severe engine damage.
3. Secure vehicle from ROLLING!
4. Cab and Chassis may require modifications
5. Consult vehicle's manufacturers' instructions concerning the electrical system before attempting any electrical connections.
6. Be sure that the serial # on this installation manual matches that of the outside of the box.
7. Flush and clean all brass fittings and fuel line from debris.
8. Keep debris from entering the internals of the system during installation. Getting debris in the water separator nipple can lock up the motor. If the motor does lock up from debris call FASS for technical assistance.

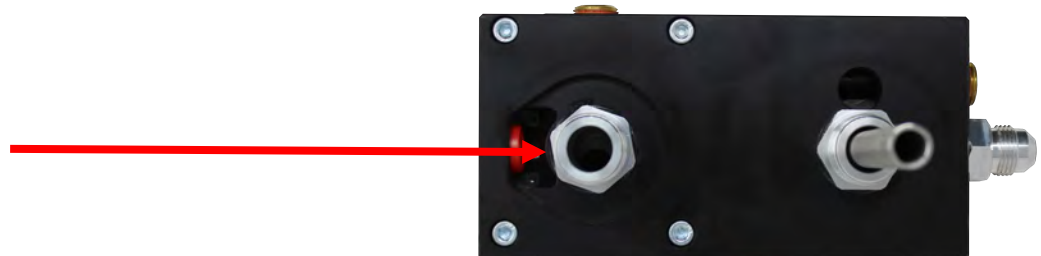

9. Wear safety glasses when operating power tools such as drills and grinders or when using a punch or chisel.
10. Properly secure lines to prevent chaffing.

**BEFORE STARTING THE INSTALLATION PROCESS LUBRICATE THE BED BOLT WITH WD-40 TO HELP WITH INSTALLATION**



**WARNING!**

**Always be sure to fill the fuel tank to full after a new FASS installation. Failure to do so can result in excessive sound output, or priming issues!**

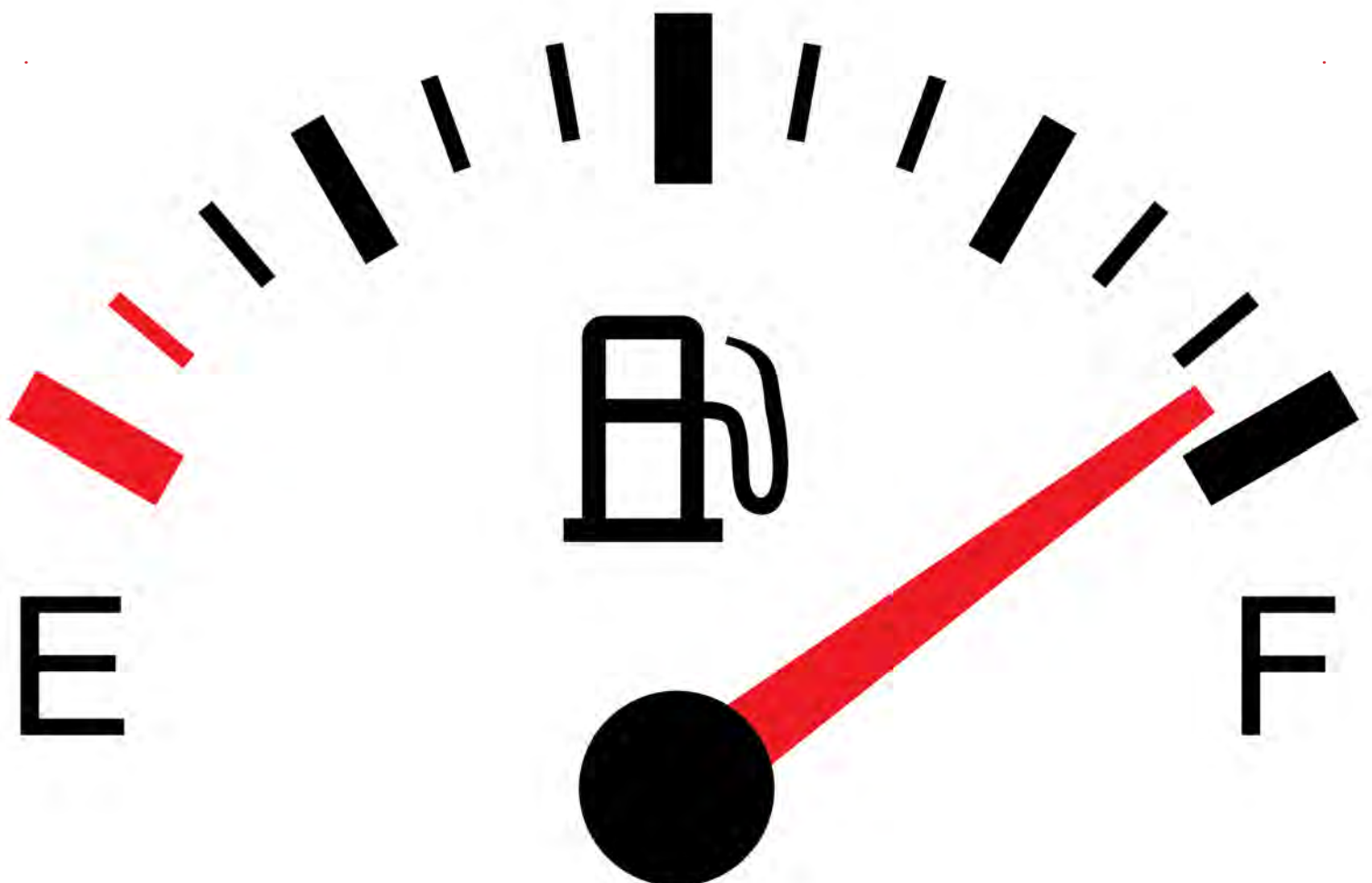

## **TITANIUM SIGNATURE SERIES 100 GPH or 165 GPH 16-18 psi (Approximately)**

Rear View



Front View

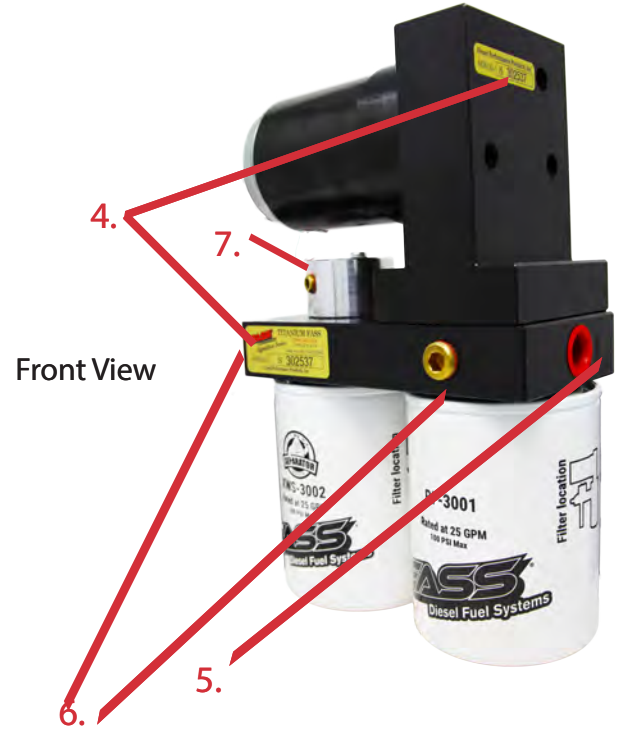

### **PUMP GUIDE:**

- 1. "E" To Engine**
- 2. "R" Return to Tank**
- 3. "H" Coolant Heater Ports**
- 4. Serial Number**
- 5. "T" Fuel Inlet**
- 6. Electric Heater Ports**
- 7. "G" Gauge Port**

### **INSTALLATION GUIDE:**

- Step 1. Install Electrical Harness**
- Step 2. Prep the FASS**
- Step 3. Mount the FASS**
- Step 4. Fuel Line Supply**
- Step 5. Review Installation**



www.fassride.com  
(866) 769.3747

# TITANIUM SIGNATURE SERIES 100 GPH or 165 GPH

**16-18 psi (Approximately)**  
Note: Going over 30 PSI WILL void warranty.

**NOTE: WARRANTY MAY BE VOID IF SILICONE  
BAND IS REMOVED FROM MOTOR!!**

*The silicone band is in place to retain motor  
wires, preventing damage to the electric motor.*





## CONTENTS

**NOTE:** Owner's Manual available for download on our website,

[www.FASSride.com](http://www.FASSride.com)



**DIELECTRIC GREASE**

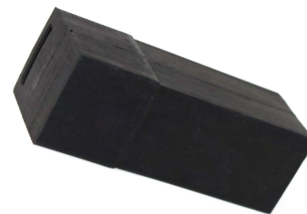

**RELAY COVER**



**TWO (2)  
OR-017**



**OR-030**

**NOTE: THESE SPARE BASE O-RINGS ARE INCLUDED WITH THE KIT IN THE EVENT OF A PINCHED O-RING DURING ASSEMBLY**



**WH-1004-3**

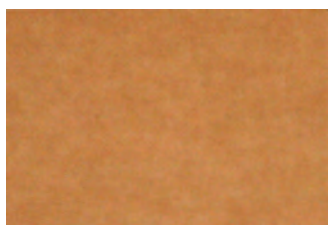

**MP-9018**



**FL-1002 x17"**



**5/8" VITON  
FL-1007**

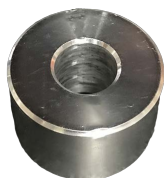

**DS-1001**



**ST-1005Px16"**



**PBR-2001**



**PFB-2002**

# MOUNTING PACKAGE CONTENTS

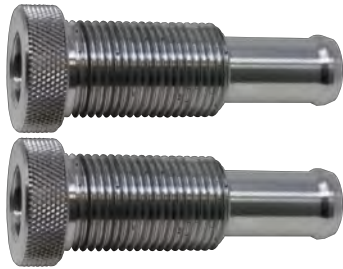

TWO (2)  
BHF-1005



TWO (2)  
OR-212



TWO (2)  
BHN-1005



TWO (2)  
HC-1001



PL-2003

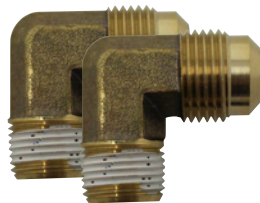

TWO (2)  
10-306



TWO (2) RING TERMINAL



10-300



DIPF-1003



HEX  
BOLT

M12.175  
60MM

M12-1.75x 45MM



FOUR (4) LOCKING  
NUT 3/8"



1/2" WASHERS



THREE (3) WA-1001D

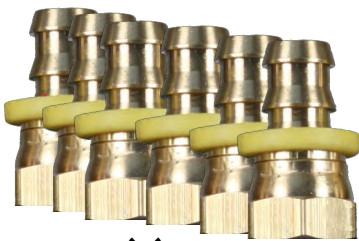

SIX (6) PL-1005



10-301



5/16" VITON  
FL-1006



FOUR (4) 3/8" WASHERS

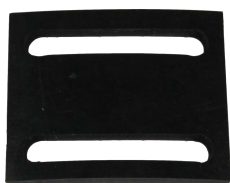

RS-2002



THREE (3)  
HEX BOLT  
1/4" -20x1  
3/4"



RS-2001



FOUR (4) HEX BOLT 3/8"  
-16x11/2"

**STEP 1:**  
**INSTALL ELECTRICAL HARNESS**

The installation of the electrical harness is done first, allowing power to be applied to the pump for lubrication purposes later in the installation.

**NOTE: USE SUPPLIED DIELECTRIC GREASE  
SPARINGLY ON ALL ELECTRICAL  
CONNECTIONS! BE SURE TO GREASE RELAY  
PIGTAIL!**



**STEP 1:**  
**INSTALL ELECTRICAL HARNESS**

The installation of the electrical harness is done first, allowing power to be applied to the pump for lubrication purposes later in the installation.

***Install the Relay Cover onto the relay on the FASS harness.***

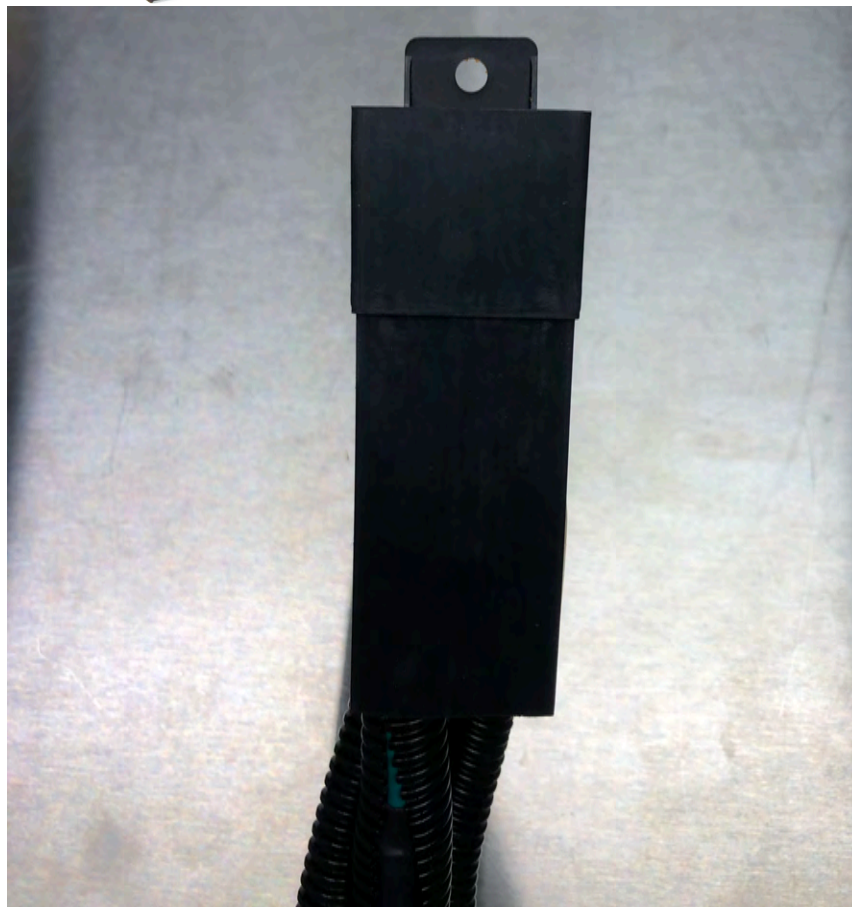
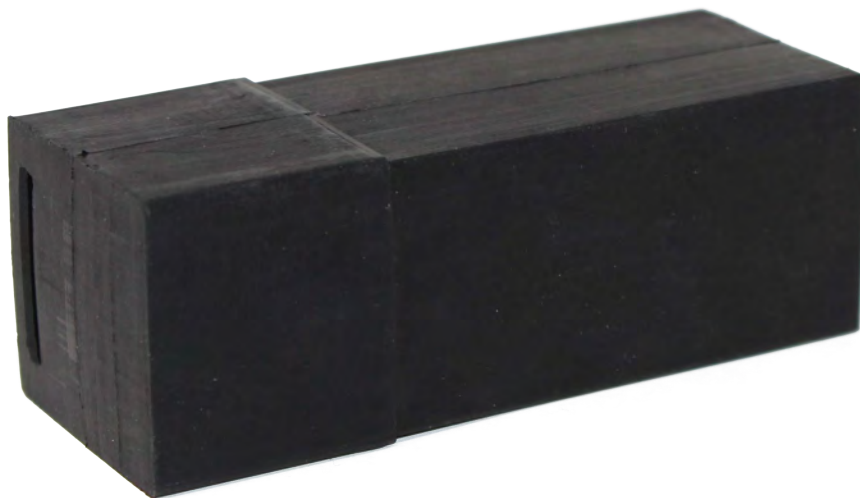

**STEP 1:**  
**INSTALL ELECTRICAL HARNESS**

The installation of the electrical harness is done first, allowing power to be applied to the pump for lubrication purposes later in the installation.

**NOTE: BE SURE TO INSTALL THE SUPPLIED  
10 AMP FUSE INTO THE FASS WIRING  
HARNESS!!**



## **STEP 1:** **INSTALL ELECTRICAL HARNESS**

The installation of the electrical harness should be completed first. This will allow power to be applied to the pump during installation.

- A.** Using ring terminals, attach red wire of the WH-1004-3 to the positive battery terminal. Attach green wire to a clean ground, preferably the negative battery terminal. Secure fuse block in a location protected from outside elements. **The use of corrosion preventative spray is recommended.**

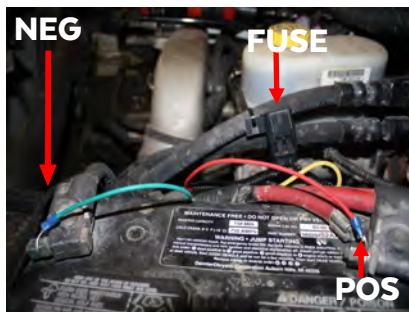

- B.** Secure Relay in an upright position, as shown, to prevent moisture from entering. Dielectric grease may be applied to prevent corrosion. Examples of locations to secure relay:



- C.** Route wire harness along frame to the approximate mounting location near the fuel tank. **Completion of this step will be addressed in the Step 3.**

## **STEP 2:** **PREPARE SUCTION & RETURN LINES**

- A. Before tank is removed or moved, identify ALL areas of clearance between the tank and the truck's bed for the best location to install the BHF assembly.



- B. Remove the filler neck and overflow tubes from the truck by loosening the clamps at both ends.



- C. Disconnect the factory suction and return line. The factory lines are re-moved by pressing in on the two tabs located in the connecting fuel line. Keep the tab on the factory return.

- D. Disconnect the factory electrical harness on top of the fuel tank.



## **STEP 2:** **PREPARE SUCTION & RETURN LINES**

- E. With the fuel tank empty of fuel, remove it from the vehicle.
- F. Clean the fuel module area then remove the lock ring on the top of the fuel tank.

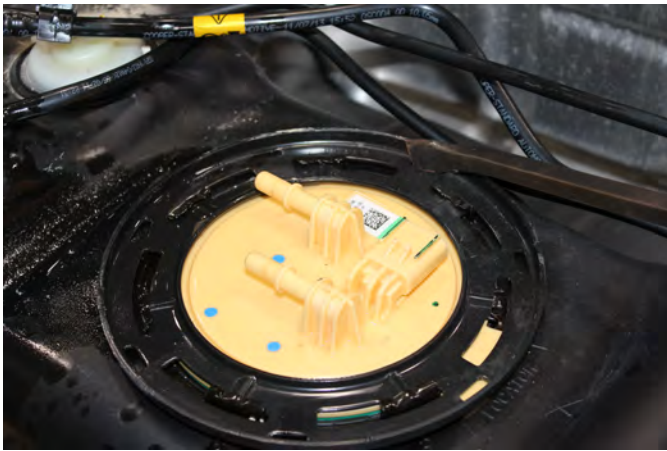

- G. Once the lock ring is removed, carefully remove pick up module from fuel tank while making note of fuel level arm.





**STEP 2:**  
**PREPARE SUCTION &  
RETURN LINES**

H. Place fuel tank module on a suitable work area. Remove connector from the OEM fuel pump by releasing the locking tabs. Cut the zip tie securing wiring and discard.

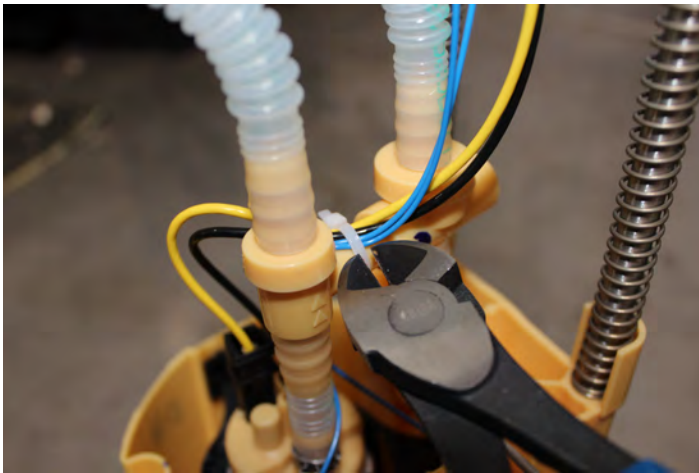
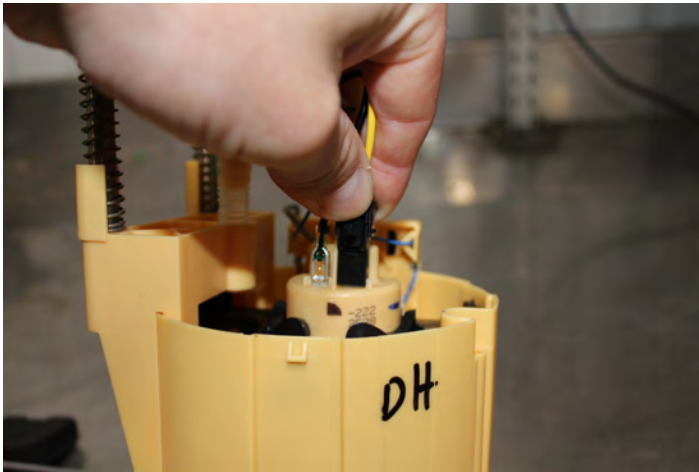

## **STEP 2:** **PREPARE SUCTION & RETURN LINES**

I. Carefully remove convoluted tubing from the fuel tank module with a razor knife, be sure not to damage the hose barb beneath the tubing. Cut the retaining tabs that secure the OEM fuel pump, remove the fuel pump from the fuel tank module. Remove the screen from the bottom of the fuel tank module.

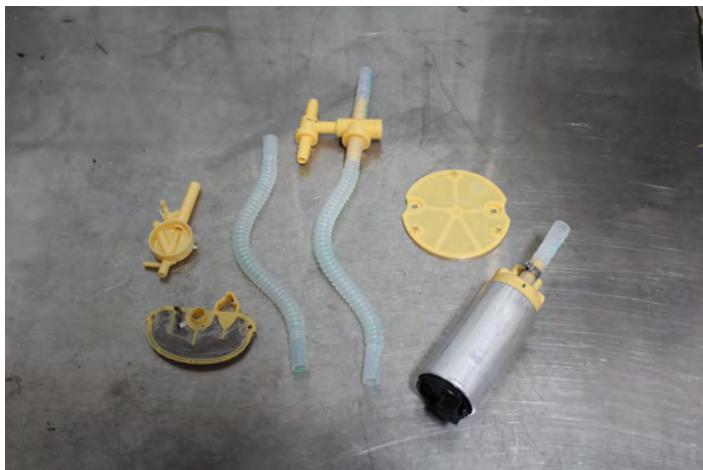
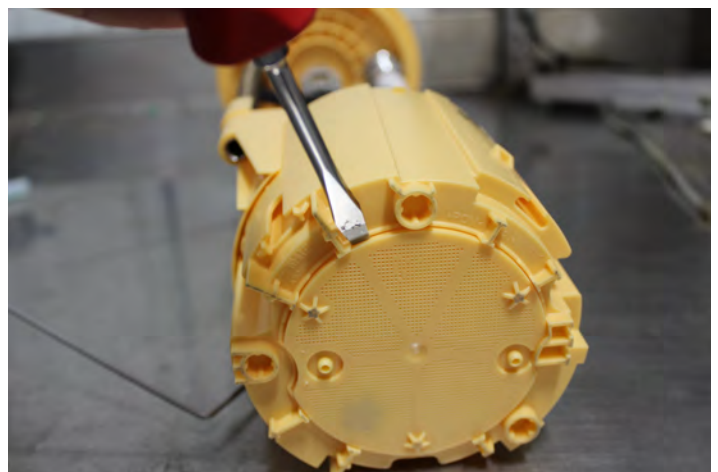
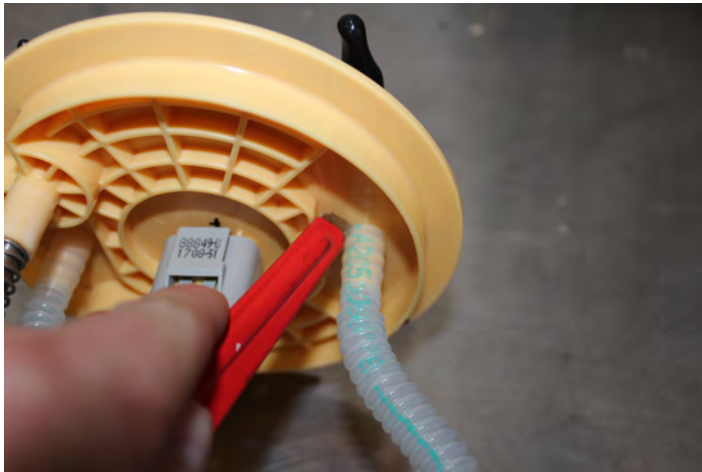

**STEP 2:**  
**PREPARE SUCTION &  
RETURN LINES**

**NOTE: These model year trucks came equipped with different style fuel tank modules. The installation process is the same, just note the different fitting installation locations below:**

Most 2005-2018 Models

Most 2021 Models

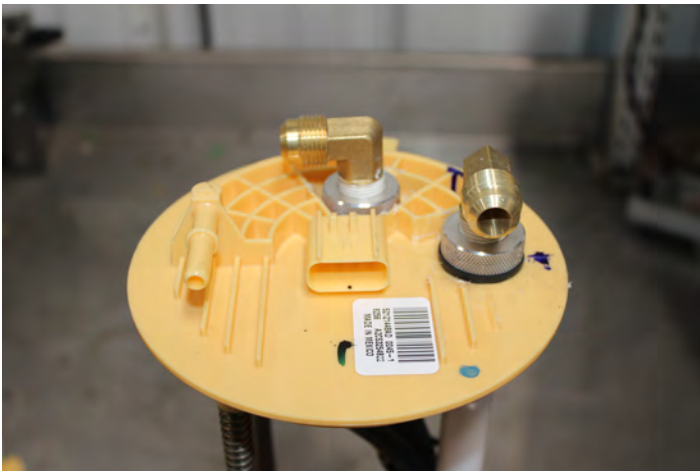

## **STEP 2:** **PREPARE SUCTION & RETURN LINES**

J. Carefully cut the OEM fuel FEED line off of the fuel tank module. Using a 7/8" hole saw, drill the center of the OEM feed port. Using a suitable grinding tool, carefully remove plastic webbing with enough clearance for a BHF-1005 while removing all plastic burrs.

**NOTE: YOU MUST CREATE AN ADEQUATE SEALING SURFACE FOR OR-212!!**

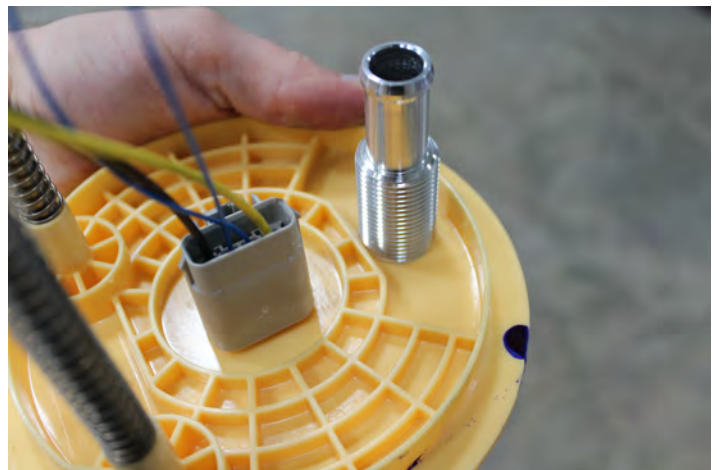
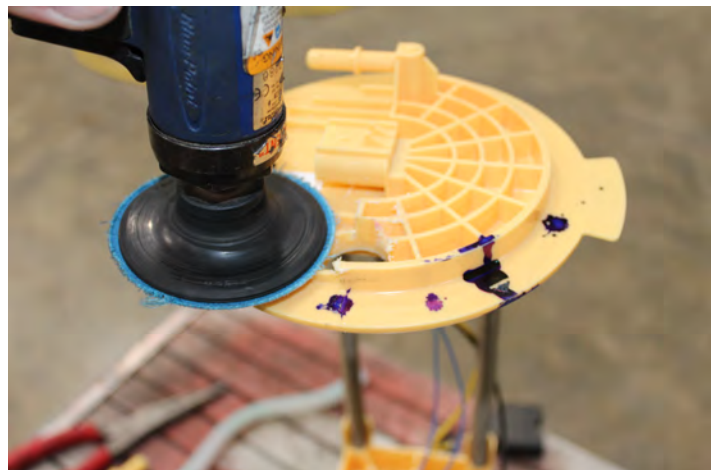
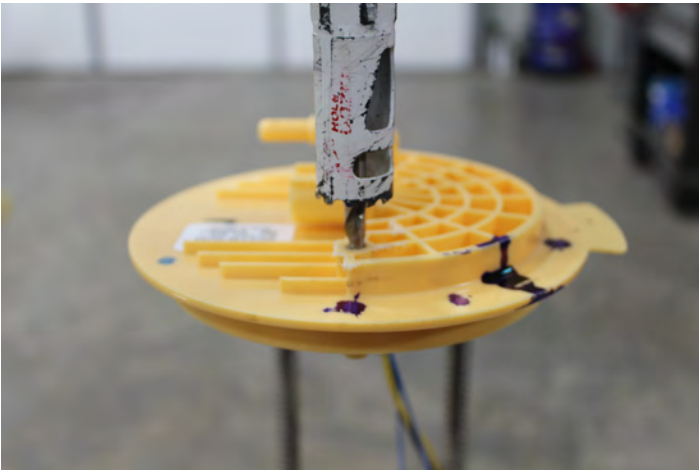

## **STEP 2:** **PREPARE SUCTION & RETURN LINES**

**K.** Mark the location for the second BHF-1005, follow the same procedure as the previous step to clearance the fuel tank module. *NOTE: YOU MUST CREATE A GOOD SEALING SURFACE FOR OR-212!!*

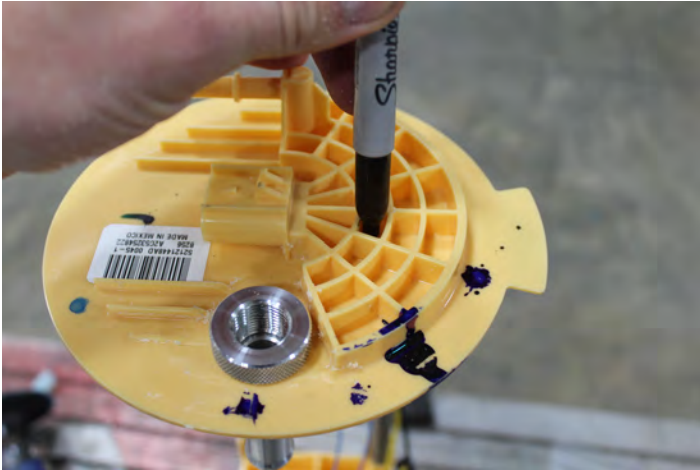

**L.** Install one 10-306 into each BHF-1005 and tighten accordingly.



## **STEP 2:** **PREPARE SUCTION & RETURN LINES**

**M.** Install one OR-212 onto each BHF-1005, install both BHF-1005 into the holes previously drilled in the fuel tank module. Apply red LocTite onto BHF-1005 threads. With a pair of pliers, carefully tighten BHF-1005/BHN-1005. ***DO NOT OVER TIGHTEN, THIS WILL DAMAGE THE GASKET!***



***BE SURE TO CHECK FOR PROPER GASKET COMPRESSION!***  
***(Different fuel tank module shown for gasket clarity)***

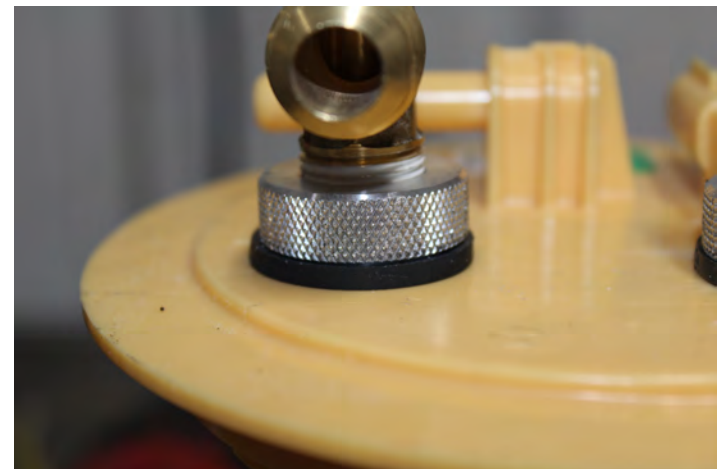
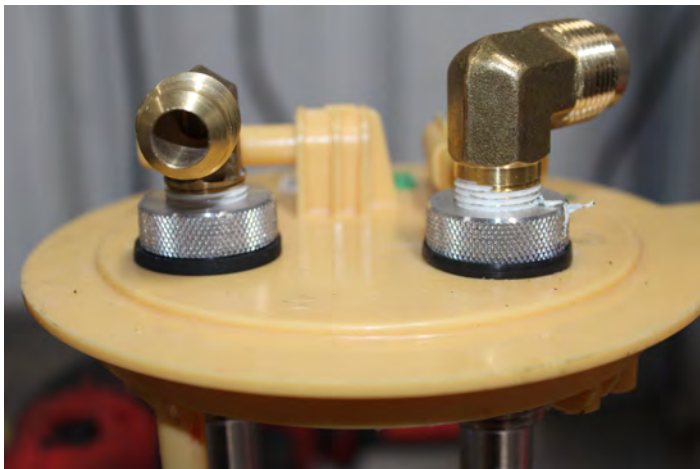

## **STEP 2:** **PREPARE SUCTION & RETURN LINES**

**VERY IMPORTANT:** Support fuel tank on both ends allowing the natural formation of the tank to take place. Failure to perform this step will hinder precision installation.



### **FUEL TANK SUPPORTS**

**N. NOTE:** INSTALL ST-1005P ONTO THE BHF-1005 THAT IS IN PLACE OF THE OEM FUEL FEED LINE! Using a tape measure, measure from the bottom of the fuel tank to the top of the o-ring sealing surface where the fuel tank module makes contact and take note of the measurement. Compress fuel tank module to the exact height measurement taken in previous step, measure and mark ST-1005P with 1/4"-1/2" clearance from bottom of fuel tank module. Cut ST-1005P to length and install onto BHF-1005 with hose clamp HC-1001. **NOTE: ACTUAL MEASUREMENTS WILL VARY FROM IMAGES!**

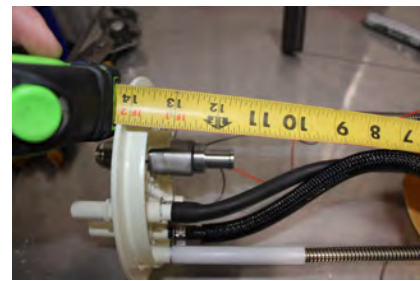
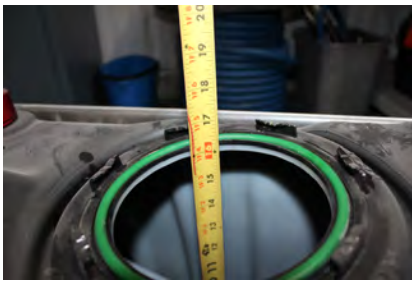

## **STEP 2:** **PREPARE SUCTION & RETURN LINES**

○ Install FL-1007 onto the second BHF-1005 with 1" of clearance to the bottom of the fuel tank module using the same procedure as step "N.". Install FL-1006 onto the OEM fuel return barb, FL-1006 may need to be trimmed to length. Neatly secure all of the fuel lines and electrical wires together using the provided cable ties.

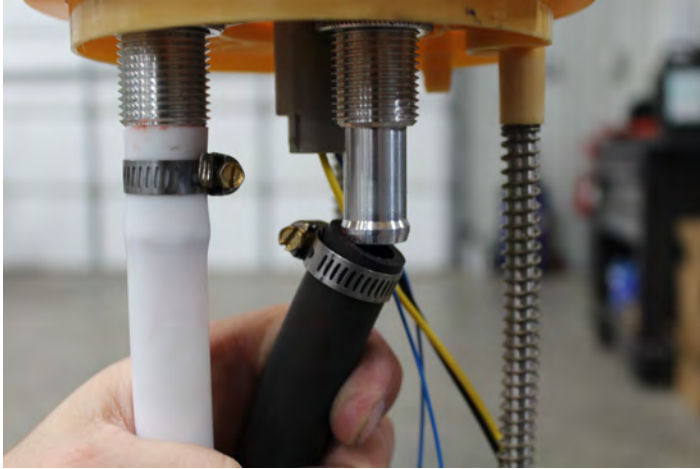



## **STEP 2:** **PREPARE SUCTION & RETURN LINES**

**P.** Carefully reinstall install pick up module making sure the leveling arm is not obstructed by the suction tube. Reinstall factory lock ring.



**Q.** Install one PL-1005 into each end of FL-1002 using oil. Loop FL-1002 over the frame, install one PL-1005 on each 10-306 and tighten accordingly.

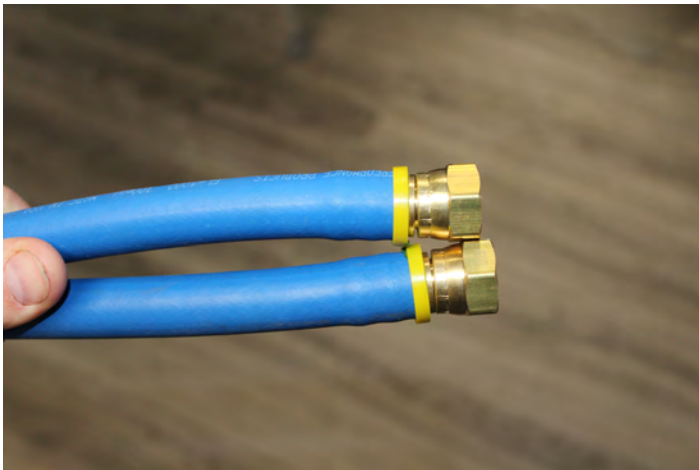

**STEP 2:**  
**PREPARE SUCTION &  
RETURN LINES**

R. Connect WH-1004-3 (addressed in Step 1) to the fuel module along with the factory fuel lines

S. Connect factory wire harness to the WH-1004-3.



T. Reattach filler neck and clamps.



**NOTE:**

**ATTENTION:** While installing fittings into Titanium pump **DO NOT** Apply side pressure to draw tube of pump

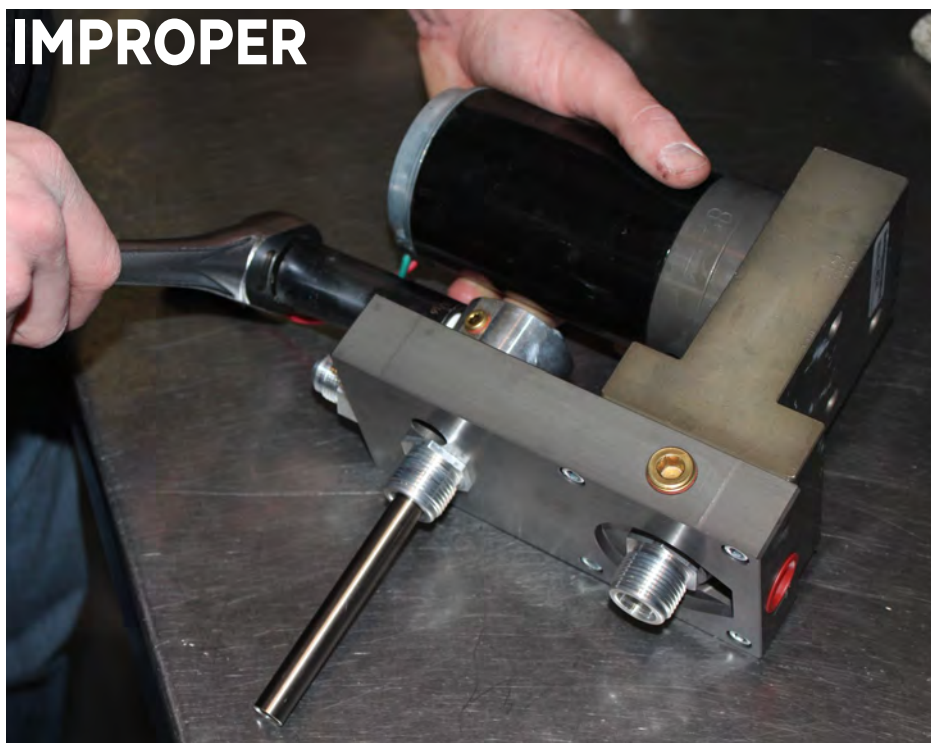
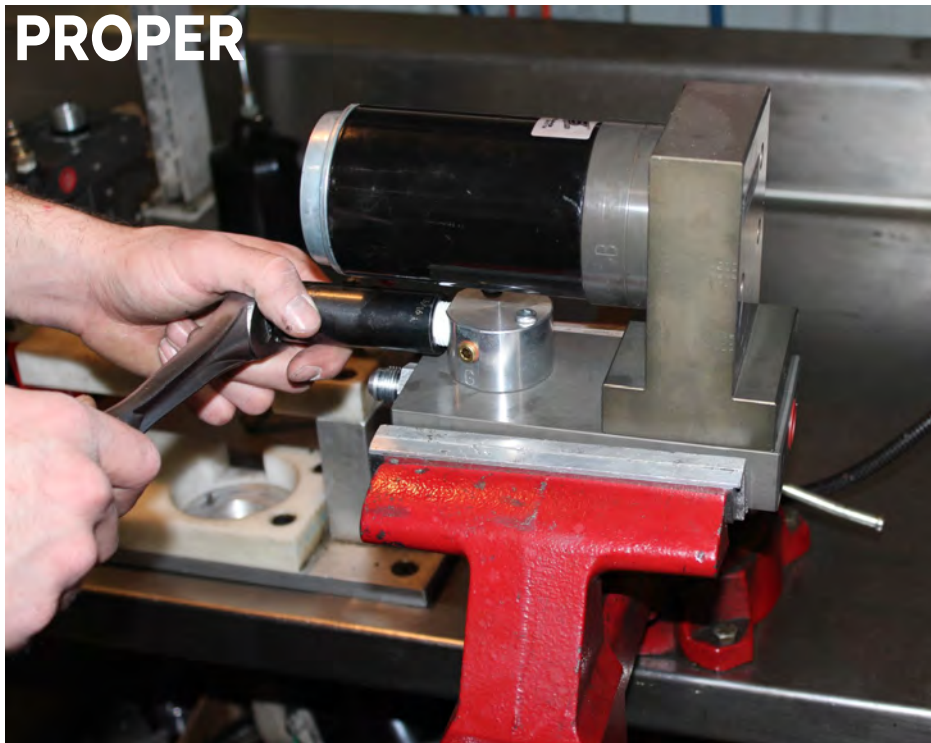

## STEP 3: MOUNT FUEL SYSTEM

**NOTE: Before installing fittings make sure to inspect for burs or flare imperfections. When cutting fuel line make sure to blow out line to keep debris from moving forward.**

- A. Install 10-300 into the "E" port and 10-301 into the "T" port of the FASS, torque to 20 ft./lbs.  
\*\*\*FITTINGS COME EQUIPPED WITH THREAD SEALANT, DO NOT USE THREAD TAPE\*\*\*

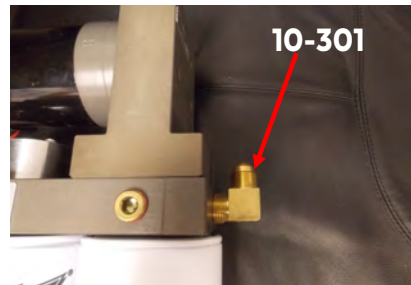

- B. For fitting purposes. Secure PBR-2001 to pump assembly lightly with (3) 1/4"-20x1 3/4 bolts and (3) WA-1001D. Assembly will be used in future steps for correct fitting of brackets. (Note: Bracket may-be flipped to accommodate your application.)

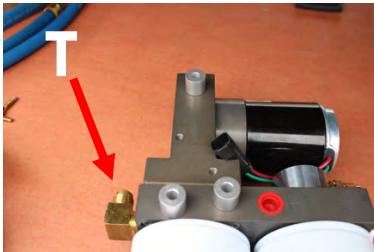

**STEP 3:**  
**MOUNT FUEL SYSTEM**

**\*\*ATTENTION\*\***

**NOTE:** SOME RAM MODELS MAY REQUIRE OUR DS-1001 ALUMINUM SPACER AND LONGER M12 1.75X60MM BOLT WHEN MOUNTING THE PFB-2002 AS SEEN BELOW!

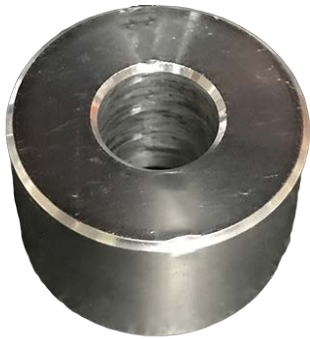

**DS-1001**



**M12 1.75X60MM**

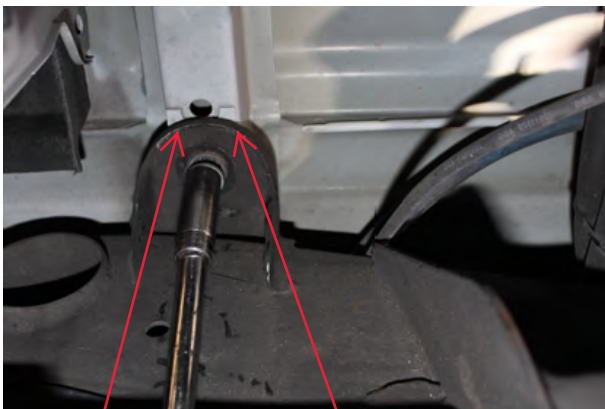

**USING THIS SPACER ALLOWS FOR PROPER CLEARANCE ON THE BED MOUNTS THAT HAVE THE ROLLED LIP LIKE THIS.**

**STEP 3:**  
**MOUNT FUEL SYSTEM**  
**1998.5-2013 Dodge Installation**

**B.** For fitting purposes. Secure PBR-2001 to pump assembly lightly with (3) 1/4"-20x1 3/4 bolts and (3) WA-1001D. This assembly will be used in future steps for correct fitting of brackets. (Note: Bracket maybe flipped to accommodate your application.)

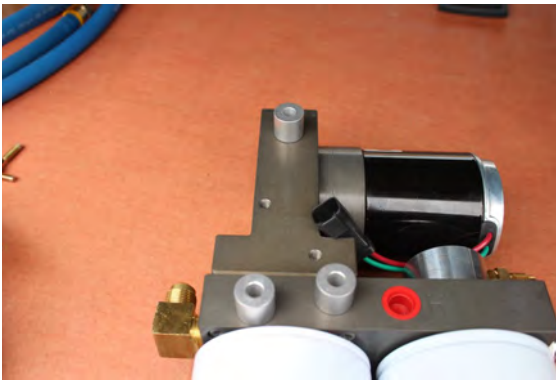

**C.** Unbolt driver side front bed bolt from bed retain bolt for future use. Align RS-2001 with PFB-2002. .



**D.** Secure PFB-2002 and RS-2001 with bed bolt in previous step.



## **STEP 3:** **MOUNT FUEL SYSTEM** **1998.5-2013 DODGE INSTALLATION**

**E.** Position the PBR-2001 to the PFB-2002 pump assembly at the mounting location and check for fit. Once location is established mark location for mounting in next step.



**F.** Assemble the FASS pump bracket PBR-2001 using the RS-2002 spacer between PFB-2002 and PBR-001 bracket with 4-3/8 bolts, nuts, and washers. **Note: Torque bolts not flange nut.**



## **STEP 3:** **MOUNT FUEL SYSTEM**

### **2014-2022 RAM INSTALLATION**

**B.** For fitting purposes. Secure PBR-2001 to pump assembly lightly with (3) 1/4"-20x1 3/4 bolts and (3) WA-1001D. This assembly will be used in future steps for correct fitting of brackets. (Note: Bracket maybe flipped to accommodate your application.)

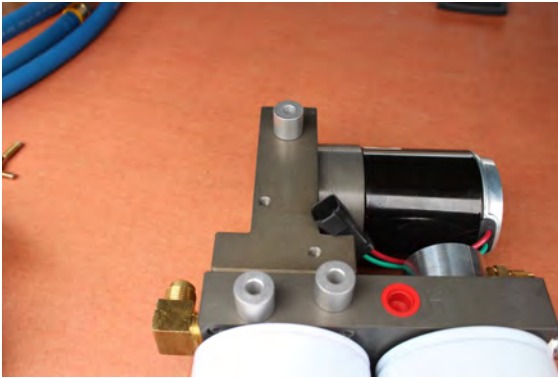

**C.** Using Bolt and Washer provided align the RS-2001 with the PFB-2002. .



**D.** Route PFB-2002 in between the DEF lines and secure PFB-2002 and RS-2001 with bed bolt in previous step.





## STEP 3: MOUNT FUEL SYSTEM 2014-2022 RAM INSTALLATION

E. Position the PBR-2001 to the PFB-2002 pump assembly at the mounting location and check for fit. **NOTE: PBR-2001 will go on the back side of PFB-2002. Once location is established mark location for mounting in next step.**



F. Assemble the FASS pump bracket PBR-2001 using the RS-2002 spacer (NOTE: PBR-2001 will go on the back side of PFB-2002) between PFB-2002 and PBR-2001 bracket with 4-3/8 bolts, nuts, and washers. **Note: Torque bolts not flange nut.**



## **STEP 3:** **MOUNT FUEL SYSTEM**

**G.** Position the PBR-2001 to the PFB-2002 pump assembly at the mounting location and check for fit. Once location is established mark location for mounting in next step.



**H.** Assemble the FASS pump bracket PBR-2001 using the RS-2002 spacer between PFB-2002 and PBR-2001 bracket with 4-3/8 bolts, nuts, and washers. **Note: Torque bolts not flange nut.**



## STEP 3: MOUNT FUEL SYSTEM

I. Once secure use (3) 1-3/4 bolts and (3) WA-1001D spacers to mount the pump to the bracket.

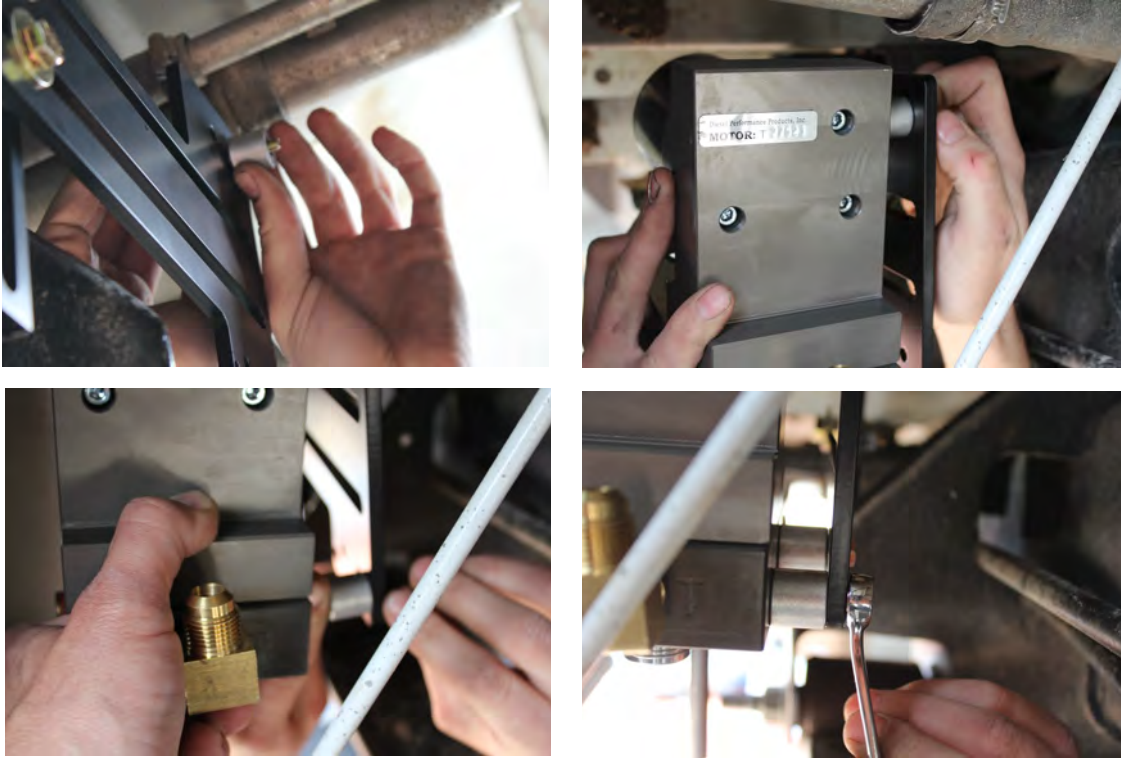

J. Connect factory plug into the FASS harness. Plug FASS harness into the fuel module in tank. Make sure to lock red slide tab. Connect female plug of the FASS harness into pump. Turn key to "on". With pump operating (you may have to bump the starter), turn pump over, liberally spray WD-40 (or equivalent) into water separator nipple lubricating Gerotor.



K. Apply motor oil to gasket located on filters. Attach to system and hand tighten.



**NOTE:**

**ATTENTION: IT MAY BE NECESSARY TO ADJUST THE PARKING BRAKE CABLE BRACKET ON SOME MODELS FOR PROPER CLEARANCE!!**



## STEP 3:

# MOUNT FUEL SYSTEM

**NOTE: If fuel pressure gauge is pulsating after FASS installation, use snubber valve (Cat Part # 7S-3795)**

- I. Apply motor oil to gasket located on filters. Attach to system and hand tighten.



**Extreme Water Separator -**  
Install XWS-3002 on side of pump with draw tube in the middle of the filter nipple.



**Particulate Filter -** Install PF-3001 on filter nipple without the draw tube. Make sure to insert O-Ring provided on nipple.



**Note: O-Ring must be put back on suction side of pump. Failure to do so can result in priming issues, cavitation or pressure losses.**

## **STEP 4:** **INSTALL FUEL LINE**

**Caution: DO NOT use sealant on AN fittings**

- A.** Route suction line to 'T' port . Cut FL-1002 to length. Insert PL-1005 in line using oil. Attach to 10-301. Torque to 18 ft./lbs. **NOTE:** Hose clamps are not recommended for push lock fittings and can damage the strength of hose. They will hold up to 300psi! Use oil on fittings and inside fuel line when installing Push-Lok fittings

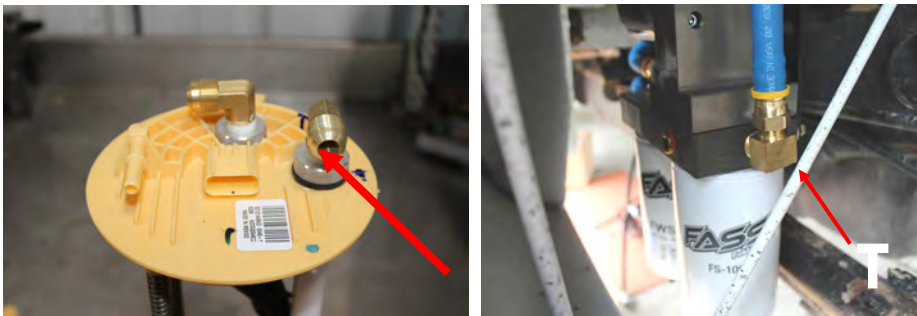

- B.** Route fuel line from the return BHF-1005 (has Viton tube on it) to the 'R' port on the FASS system with a gentle bend. Cut and insert the PL-1005 fitting to the hose. Use oil. Attach fitting to the 'R' port. Torque to 18 ft/lbs.



- C.** Insert PL-1005 in remaining fuel line. Connect to the 'E' port of the FASS system. Use oil. Torque to 18 ft./lbs. Route this line up to the injection pump.



## **STEP 4:** **INSTALL FUEL LINE**

### **2003-2018 CP3 (Injection Pump)**

**D.** Disconnect factory fuel line from inlet side of the factory injection pump and install the DIPF-1003 fuel fitting. (Note: This is where the fuel line from the fuel filter housing enters the injection pump.) Torque to 18 ft./lbs. NOTE: Photo shows the common rail system on the 2003 through 2007 trucks. For 2007.5-newer please skip to F. For 1998.5-2002 trucks, please skip to the next page.

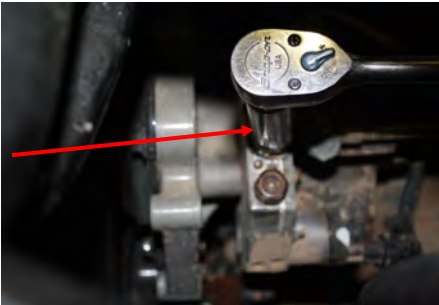

**E.** Cut fuel line to length and insert PL-2003 90° (or PL-1005 for 2007.5-2017) fitting using oil. Attach to DIPF-1003. Torque to 18 ft./lbs.

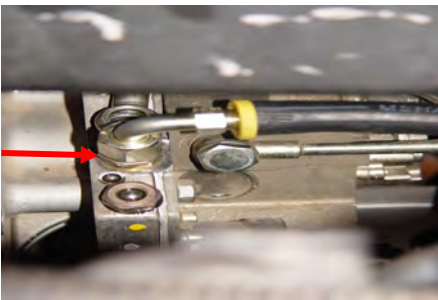

Note: Secure all fuel lines with cable ties. Cable ties are an economical way to prevent the possibility of problems occurring!

**F.** Cut fuel line and insert PL-1005 fitting using oil. Attach to DIPF-1003 fitting ( Number 1) on the injection pump. Torque to 18 lb./ft.<sup>2</sup> (1) is Supply line and (2) is Return line

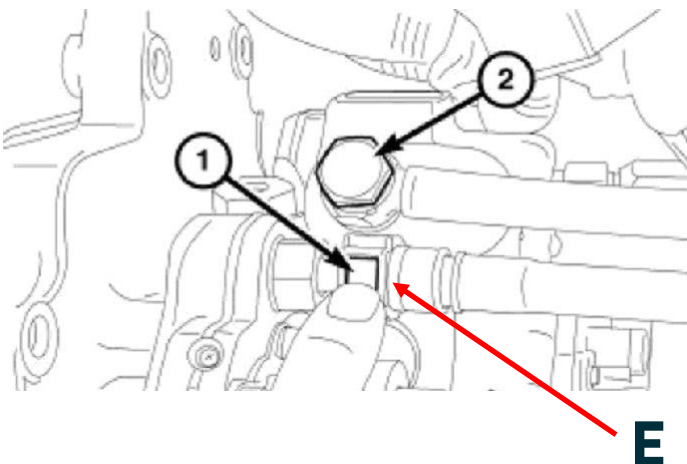

NOTE: Photo shows the common rail system on the 2007.5 through 2017 trucks.

**E**

## **STEP 4:** **INSTALL FUEL LINE**

### **1998.5 - 2002 VP44 (Injection Pump)**

**D.** Disconnect factory fuel line from inlet side of the factory injection pump, Install the DIPF-1003 fuel fitting into this inlet port. (Note: This is where the suction fuel line from the fuel filter enters the injection pump.)



**E.** Measure and cut fuel line. Insert PL-2003 90° Push-Lok fitting using oil. Install fitting onto DIPF-1003. Torque to 18 ft/lbs.





## **STEP 5:**

# **REVIEW INSTALLATION**

- 1. Blow out any open lines/cover any open ports**
- 2. Bolts and fasteners properly tightened?**
- 3. Electrical harness and fuel lines secured and properly tightened? Reconnect the battery.**
- 4. Has the system been primed?**
  - a. Turn key to the ignition position, turning on the FASS pump for 15 sec..**
  - b. Crank engine and allow to run for at least 1 minute.**
- 5. Check for leaks.**
- 6. Start the engine**
- 7. Recheck all fluid and filter connections for leaks**
- 8. This pump comes with a 1 Year Manufacturer's Warranty based on the date it has been manufactured. To receive your extended Lifetime Warranty, you have 30 days from date of purchase to send the completed warranty information**

## **STEP 5:** **REVIEW INSTALLATION**

1. Blow out any open lines/cover any open ports
2. Bolts and fasteners properly tightened?
3. Electrical harness and fuel lines secured and properly tightened? Reconnect the battery.
4. Has the system been primed?
  - a. Turn key to the ignition position, turning on the FASS pump for 15 sec..
  - b. Crank engine and allow to run for at least 1 minute.
5. Check for leaks.
6. Start the engine
7. Recheck all fluid and filter connections for leaks
8. This pump comes with a 1 Year Manufacturer's Warranty based on the date it has been manufactured. To receive your extended Lifetime Warranty, you have 30 days from date of purchase to send the completed warranty information

**To assist with priming your FASS pump crack the FF-3003. Put power to the FASS pump to activate the pump. When the tone of the pump changes you can tighten up the fuel filter. If you need a video of the priming process go to [www.FASSride.com](http://www.FASSride.com).**



**Note: The Red Plastic Plugs located in the “H” ports can stay in place fuel will not flow through these ports. Coolant can be plumbed into these ports to heat the fuel in the Winter months.**



## **LIMITATION OF LIFETIME WARRANTY**

Disclaimer: To help insure you receive the proper system and customer support at the local level, FASS has a VIP and Authorized Dealer network representing FASS products. This is one reason you must purchase through a dealer to comply with our warranty policies. If you do not, there is no warranty! We recommend you go to [www.FASSride.com](http://www.FASSride.com), click "Find a Dealer", put in their ZIP code, select the type of dealer, and see if the company you purchased from is listed. If they are not, put their phone number in the field below the ZIP code field to see if they are listed. Below these two fields is a list of "Terminated/Unauthorized" dealers. You may want to review this list. If the company is not listed or is on the "Terminated/Unauthorized" list, we suggest you return the product immediately to that dealer and call FASS. We'll recommend you to the nearest dealer.

Diesel Performance Products, Inc. (hereafter "SELLER") gives Limited Warranty as to description, quality, merchantability, fitness for any product's purpose, productiveness, or any other matter of SELLER'S product sold herewith. The SELLER shall be in no way responsible for the product's open use and service and the BUYER hereby waives all rights other than those expressly written herein. This Warranty shall not be extended or varied except by a written instrument signed by SELLER and BUYER.

When MANUFACTURER receives the "ORIGINAL" PRODUCT REGISTRATION form with a copy of the "BILL OF SALE/SALES RECEIPT" within 30 days of the sale, then the following applies! The Warranty will then and only then be validated to that of which typically accompanies your unit for your specific application from the date of sale or for recommended service life and limited solely to the original purchaser and/or vehicle and parts contained within the product's kit. This warranty does not cover normal wear on consumable items such as but not limited to filters, fuel line, wire harness & etc. The warranty does not cover seized gears due to lack of filtration. Warranty is voided if used with other than diesel fuel. Returned items will arrive prepaid to the place of purchase. Diesel Performance Products, Inc. will repair, without cost, any product found to be defective during the warranty period; parts only, or at its option, will replace such products in exchange for the product. Repair or replacements are warranted for the remainder of the original warranty period. All Warranty claims are subject to approval by Diesel Performance Products, Inc.

A Return Material Authorization (RMA) number must be obtained before any product is to be returned to Diesel Performance Products, Inc. for warranty consideration, repair or product return. Requests for product returns must be offset by an equal value order. Return parts must be completed and in resalable condition. No returns after 30 days.

The following information is required to obtain a RMA number before returning product:

Your Name, Address, and Phone Number's

Model and Serial Number (Not Motor Number) Example: Model HD Series, Serial: 00125966 VIN Number of Vehicle

Date of Purchase

Nature of Problem

RMA and Product Serial Number must be on all paperwork and correspondence. Failure to obtain the required information or paperwork will result in \$25.00/item penalty and delay or denial of any warranty claim.

Under no circumstances shall the SELLER and/or MANUFACTURER be liable for any labor charged or travel time incurred in diagnosis for defects, removal, or reinstallation of this product, or any other contingent expenses.

Under no circumstances shall the SELLER and/or MANUFACTURER be liable for any damage or expenses insured by reason of the use or sale of any such equipment. This warranty does not apply to products which Diesel Performance Products, Inc. has determined to have been misused or abused, improperly maintained by the user, or where the malfunction or defect can be attributed to the use of non-genuine Diesel Performance Products, Inc. parts.

IN THE EVENT THAT THE BUYER DOES NOT AGREE WITH THIS AGREEMENT: THE BUYER MAY PROMPTLY RETURN THIS PRODUCT, IN A NEW AND UNUSED CONDITION, WITH A DATED PROOF OF PURCHASE, TO THE PLACE OF PURCHASE WITHIN THIRTY (30) DAYS FROM DATE OF PURCHASE FOR A FULL REFUND LESS SHIPPING.

THE INSTALLATION OF THIS PRODUCT INDICATES THAT THE BUYER HAS READ AND UNDERSTANDS THIS AGREEMENT AND ACCEPTS ITS TERMS AND CONDITIONS.